

## FEATURES

- Ultra-wide 4:1 input voltage range
- High efficiency up to 88%
- No-load power consumption as low as 0.12W
- I/O isolation test voltage: 1.5k VDC
- Operating ambient temperature range: -40°C to +85°C
- Input under-voltage protection, output short-circuit, over-current and over-voltage protection
- Meet CISPR32/EN55032 CLASS A, without extra components
- Industry standard pin-out
- Meets EN50155 standards

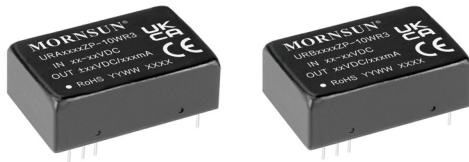

URA\_ZP-10WR3 & URB\_ZP-10WR3 series are isolated 10W DC-DC converter products with an extremely wide voltage input range of 9-36VDC or 18-75VDC, input to output isolation voltage of 1500VDC, input under-voltage protection, output short-circuit, over-current and over-voltage protection. They meet CLASS A of CISPR32/EN55032 EMI standards without external components and they are widely used in applications such as industrial controls, electric power, instrumentation, communications and railway.

## Selection Guide

Certification	Part No.	Input Voltage (VDC)		Output		Full Load Efficiency <sup>②</sup> (%) Min./Typ.	Capacitive Load <sup>③</sup> (μF)Max.
		Nominal (Range)	Max. <sup>①</sup>	Voltage(VDC)	Current (mA) Max./Min.		
EN/BS EN	URA2405ZP-10WR3	24 (9-36)	40	±5	±1000/0	81/83	1000
	URA2412ZP-10WR3			±12	±416/0	85/87	470
	URA2415ZP-10WR3			±15	±333/0	85/87	330
	URB2403ZP-10WR3			3.3	2400/0	84/86	1200
	URB2405ZP-10WR3			5	2000/0	85/87	1000
	URB2412ZP-10WR3			12	833/0	85/87	470
	URB2415ZP-10WR3			15	667/0	85/87	330
	URB2424ZP-10WR3			24	416/0	86/88	100
	URA4805ZP-10WR3	48 (18-75)	80	±5	±1000/0	81/83	1000
	URA4812ZP-10WR3			±12	±416/0	85/87	470
	URA4815ZP-10WR3			±15	±333/0	85/87	330
	URB4803ZP-10WR3			3.3	2400/0	83/85	1200
	URB4805ZP-10WR3			5	2000/0	84/86	1000
	URB4812ZP-10WR3			12	833/0	85/87	470
	URB4815ZP-10WR3			15	667/0	85/87	330
	URB4824ZP-10WR3			24	416/0	86/88	100

Notes: ① Exceeding the maximum input voltage may cause permanent damage;  
 ② Efficiency is measured at nominal input voltage and rated output load;  
 ③ The specified maximum capacitive load value for Vo1 and Vo2 output is identical;  
 ④ We suggest to connect an external electrolytic capacitor if there is a spike voltage at the input, details please refer to application circuit.

## Input Specifications

Item	Operating Conditions	Min.	Typ.	Max.	Unit	
Input Current (full load / no-load)	24VDC nominal input series, nominal input voltage	3.3VDC single output	--	380/12	389/25	mA
		5VDC single output	--	474/6	485/15	
		others	--	502/5	515/12	
	48VDC nominal input series, nominal input voltage	3.3VDC single output	--	192/5	197/20	
		5VDC single output	--	240/6	245/15	
		others	--	251/4	258/8	
Reflected Ripple Current	24VDC nominal input series, nominal input voltage	--	40	--		
	48VDC nominal input series, nominal input voltage	--	30	--		

Surge Voltage (1sec. max.)	24VDC nominal input series	-0.7	--	50	VDC
	48VDC nominal input series	-0.7	--	100	
Start-up Voltage	24VDC nominal input series	--	--	9	
	48VDC nominal input series	--	--	18	
Under-voltage Protection	24VDC nominal input series	5.5	6.5	--	
	48VDC nominal input series	12	15.5	--	
Input Filter		PI filter			
Hot Plug		Unavailable			
Ctrl *	Module on	Ctrl pin open or pulled high (3.5-12VDC)			
	Module off	Ctrl pin pulled low to GND (0-1.2VDC)			
	Input current when off	--	6	10	mA

Note: \*The Ctrl pin voltage is referenced to input pin GND.

### Output Specifications

Item	Operating Conditions	Min.	Typ.	Max.	Unit	
Voltage Accuracy <sup>①</sup>	0%-100% load	3.3VDC/5VDC single output	--	±0.5	±2	%
		Others	--	±1	±3	
Linear Regulation	Input voltage variation from low to high at full load	Vo1	--	±0.2	±0.5	
		Vo2	--	±0.5	±1	
Load Regulation <sup>②</sup>	5%-100% load	Vo1	--	±0.5	±1	
		Vo2	--	±0.5	±1.5	
Cross Regulation	Dual output, Vo1 load at 50%, Vo2 load at range of 25%-100%	--	--	±5		
Transient Recovery Time		--	300	500	µs	
Transient Response Deviation	25% load step change, nominal input voltage	3.3VDC/5VDC single output	--	±5	±8	%
		Others	--	±3	±5	
Temperature Coefficient	Full load	--	--	±0.03	%/°C	
Ripple & Noise <sup>③</sup>	20MHz bandwidth	--	40	80	mVp-p	
Over-voltage Protection	Input voltage range	110	--	160	%Vo	
Over-current Protection	Input voltage range	3.3VDC/5VDC single output	110	160	230	%Io
		Others	110	140	190	
Short-circuit Protection	Input voltage range	Continuous, self-recovery				

Note: ①At 0% - 5% load, the Max. output voltage accuracy of ±5VDC output converter is ±5%, the Max. output voltage accuracy of 3.3VDC/5VDC output converter is ±3%;  
 ②Load regulation for 0% - 100% load increases to ±5%;  
 ③Under 0% -5% load conditions, ripple & noise does not exceed 5%Vo. The "parallel cable" method is used for ripple and noise test, please refer to DC-DC Converter Application Notes for specific information.

### General Specifications

Item	Operating Conditions	Min.	Typ.	Max.	Unit
Isolation	Input-output Electric Strength Test for 1 minute with a leakage current of 1mA max.	1500	--	--	VDC
Insulation Resistance	Input-output resistance at 500VDC	1000	--	--	MΩ
Isolation Capacitance	Input-output capacitance at 100kHz/0.1V	--	2000	--	pF
Operating Temperature	See Fig. 1	-40	--	+85	°C
Storage Temperature		-55	--	+125	
Storage Humidity	Non-condensing	5	--	95	%RH
Pin Soldering Resistance Temperature	Soldering spot is 1.5mm away from case for 10 seconds	--	--	+300	°C
Vibration(EN62368)		10-150Hz, 5G, 0.75mm. along X, Y and Z			
Vibration(EN50155)		IEC/EN61373 - Category 1, Grade B			
Switching Frequency *	PWM mode	--	350	--	kHz
MTBF	MIL-HDBK-217F@25°C	1000	--	--	k hours

Note: \*Switching frequency is measured at full load. The module reduces the switching frequency for light load (below 50%) efficiency improvement.

### Mechanical Specifications

Case Material	Aluminum alloy
Dimensions	32.00 x 20.00 x 10.80mm
Weight	12.0g(Typ.)
Cooling Method	Free air convection

### Electromagnetic Compatibility (EMC)

Emissions	CE	CISPR32/EN55032	CLASS A (without extra components)/ CLASS B (see Fig.3-② for recommended circuit)	
	RE	CISPR32/EN55032	CLASS A (without extra components)/ CLASS B (see Fig.3-② for recommended circuit)	
Immunity	ESD	IEC/EN61000-4-2	Contact $\pm 4\text{kV}$	perf. Criteria B
	RS	IEC/EN61000-4-3	10V/m	perf. Criteria A
	EFT	IEC/EN61000-4-4	$\pm 2\text{kV}$ (see Fig.3-① for recommended circuit)	perf. Criteria B
	Surge	IEC/EN61000-4-5	line to line $\pm 2\text{kV}$ (see Fig.3-① for recommended circuit)	perf. Criteria B
	CS	IEC/EN61000-4-6	10 Vr.m.s	perf. Criteria A
	Immunities of voltage dip, drop and short interruption	IEC/EN61000-4-29	0%, 70%	perf. Criteria B

### Electromagnetic Compatibility (EMC) (EN50155)

EMI	CE	EN50121-3-2	150kHz-500kHz	99dBuV(see Fig.3-② for recommended circuit)	
	RE	EN50121-3-2	30MHz-230MHz	40dBuV/m at 10m(see Fig.3-② for recommended circuit)	
EMS	ESD	EN50121-3-2	Contact $\pm 6\text{kV}$ /Air $\pm 8\text{kV}$		perf. Criteria B
	RS	EN50121-3-2	20V/m		perf. Criteria A
	EFT	EN50121-3-2	$\pm 2\text{kV}$ 5/50ns 5kHz(see Fig.3-① for recommended circuit)		perf. Criteria A
	Surge	EN50121-3-2	line to line $\pm 1\text{kV}$ ( $42\Omega$ , $0.5\mu\text{F}$ ) (see Fig.3-① for recommended circuit)		perf. Criteria A
	CS	EN50121-3-2	0.15MHz-80MHz	10 Vr.m.s	perf. Criteria A

### Typical Characteristic Curves

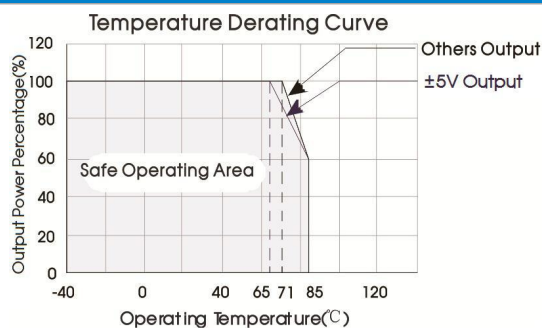
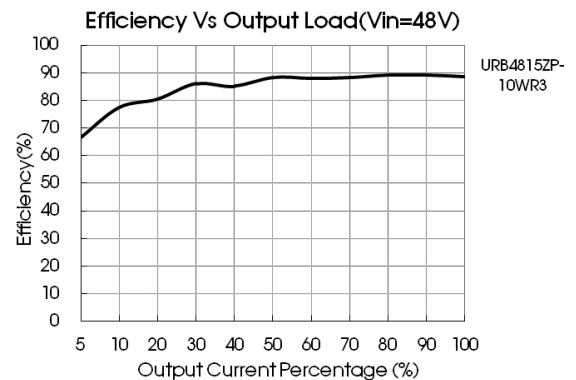
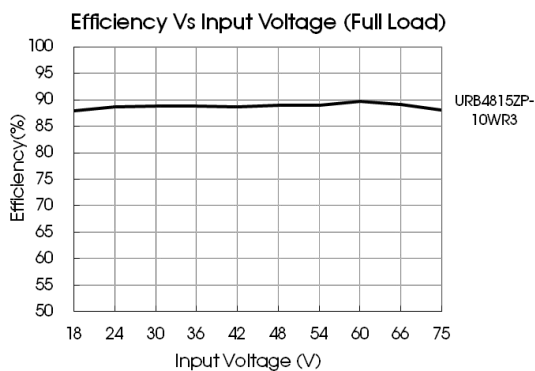
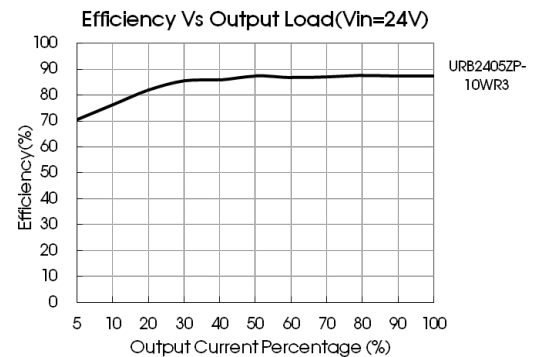
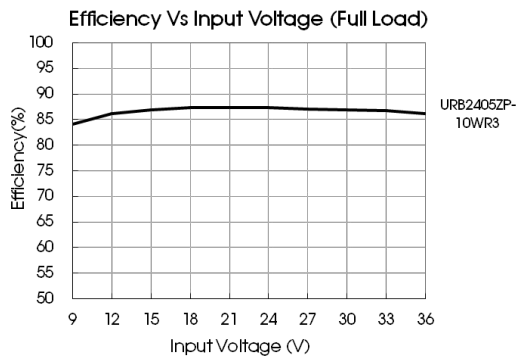
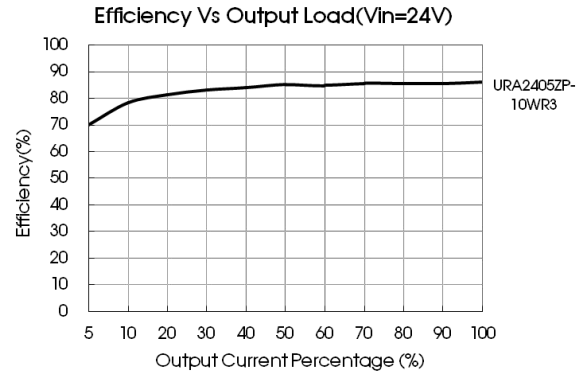
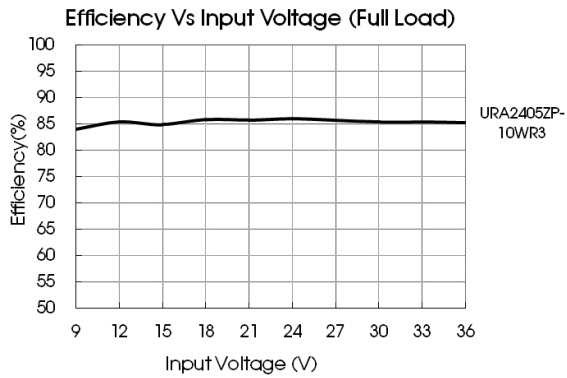

Fig. 1



## Design Reference

### 1. Typical application

All DC-DC converters of this series are tested before delivery using the recommended circuit shown in Fig. 2.

Input and/or output ripple can be further reduced by appropriately increasing the input & output capacitor values  $C_{in}$  and  $C_{out}$  and/or by selecting capacitors with a low ESR (equivalent series resistance). Also make sure that the capacitance is not exceeding the max. capacitive load value of the product.

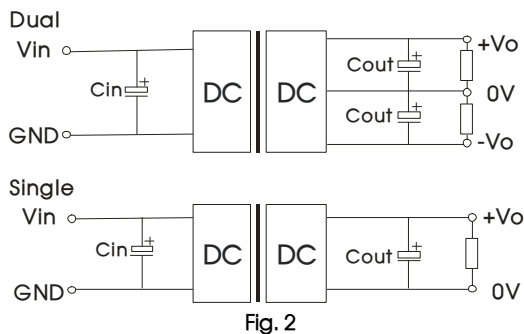

$V_{in}$ (VDC)	$V_{out}$ (VDC)	$C_{in}$	$C_{out}$
24	3/5/±5	100µF/50V	10µF/16V
	12/15/±12/±15		10µF/25V
	24		10µF/50V
48	3/5/±5	10µF - 47µF/100V	10µF/16V
	12/15/±12/±15		10µF/25V
	24		10µF/50V

### 2. EMC compliance circuit

3.3VDC/5VDC single output :

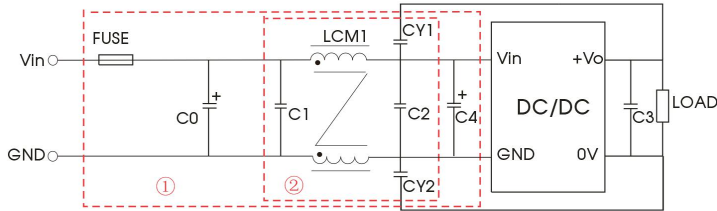

Parameter description:

Model	Vin: 24VDC	Vin: 48VDC
FUSE	Select FUSE value according to actual input current	
C0, C4	330 $\mu$ F/50V	330 $\mu$ F/100V
C1, C2	10 $\mu$ F/50V	10 $\mu$ F/100V
LDM1	10 $\mu$ H	
LCM1	1.4-1.7mH (TN150P-RH12.7*12.7*7.9)	
C3	Refer to the Cout in Fig.2	
CY1, CY2	1nF/2kV	

Others:

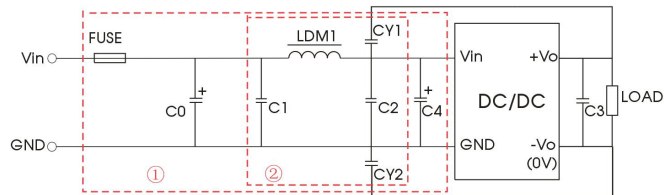
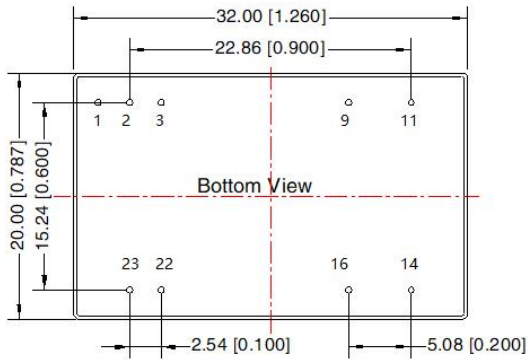
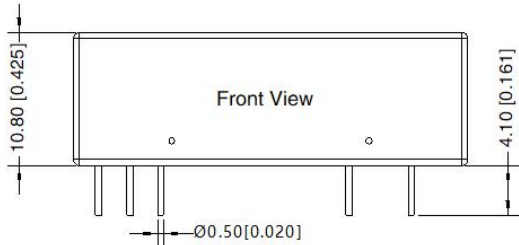

Fig. 3

Notes: For EMC tests we use Part ① in Fig. 3 for immunity and part ② for emissions test. Selecting based on needs.

3. The products do not support parallel connection of their output

## Dimensions and Recommended Layout



Note:  
Unit: mm[inch]  
Pin diameter tolerances:  $\pm 0.10[\pm 0.004]$   
General tolerances:  $\pm 0.50[\pm 0.020]$

THIRD ANGLE PROJECTION

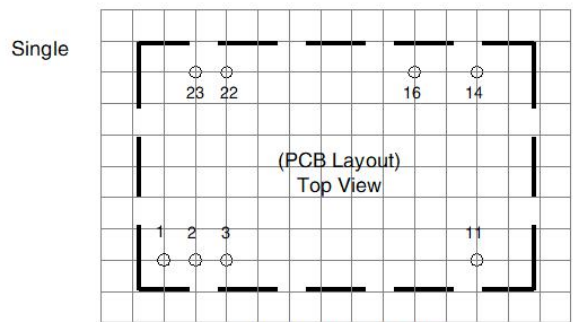
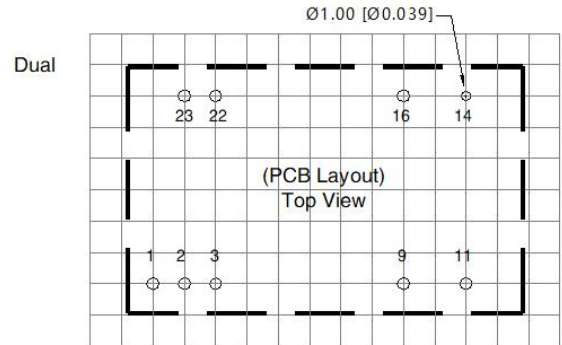

Note: Grid 2.54\*2.54mm

Pin-Out		
Pin	Single	Dual
1	Ctrl	Ctrl
2,3	GND	GND
9	No Pin	0V
11	NC	-Vo
14	+Vo	+Vo
16	0V	0V
22,23	Vin	Vin

NC: Pin to be isolated from circuit