



■ Features :

- True sine wave output (THD<3%)
- High surge power up to 6000W
- U.P.S. mode and energy saving mode (selectable)
- High efficiency up to 92%
- Power ON-OFF switch
- Standby saving mode can be selectable
- Front panel indicator for operation status
- Thermostatically controlled cooling fan
- Protections: Bat. low alarm / Bat. low shutdown / Over voltage / Over temp. / Output short / Input polarity reverse / Overload / AC circuit breaker
- Application : Home appliance, power tools, office and portable equipment, vehicle and yacht ...etc.
- Built-in solar / AC charger
- Support RS-232 communication (communication cable RJ11-RS232 included) Note.7
- 3 years warranty



SPECIFICATION

MODEL NO.		TN-3000-112□	TN-3000-124□	TN-3000-148□	TN-3000-212□	TN-3000-224□	TN-3000-248□
		□ = A, F, G			□ = B, C, D, G		
OUTPUT	RATED POWER (Typ.)	3000W					
	MAXIMUM OUTPUT POWER (Typ.)	3450W for 180 sec. / 4500W for 10 sec. / surge power 6000W for 30 cycles					
	AC VOLTAGE	Factory setting set at 110VAC			Factory setting set at 230VAC		
		100 / 110 / 115 / 120VAC selectable by setting button S.W			200 / 220 / 230 / 240VAC selectable by setting button S.W		
	FREQUENCY Note.11	60±0.1Hz 50/60Hz selectable by setting button S.W			50±0.1Hz 50/60Hz selectable by setting button S.W		
	WAVEFORM Note.8	True sine wave (THD<3%)					
	AC REGULATION (Typ.)	±3%					
	TRANSFER TIME (Typ.)	10ms inverter → → by pass					
SAVING MODE (Typ.)	Default disabled. Load ≤5W will be changed to standby mode						
FRONT PANEL INDICATOR	Battery voltage level, output load level, saving mode, fault and operation status						
INPUT	BAT. VOLTAGE	12V	24V	48V	12V	24V	48V
	VOLTAGE RANGE (Typ.) Note.3,6	10.5 ~ 15VDC	21 ~ 30VDC	42 ~ 60VDC	10.5 ~ 15VDC	21 ~ 30VDC	42 ~ 60VDC
	DC CURRENT (Typ.) Note.4	300A	150A	75A	300A	150A	75A
	NO LOAD DISSIPATION (Typ.)	≤ 10W @ standby saving mode					
	OFF MODE CURRENT DRAW (Typ.)	≤ 1mA					
	EFFICIENCY (Typ.) Note.1	88%	90%	91%	89%	91%	92%
BATTERY TYPES	Open & sealed lead acid battery						
BATTERY INPUT PROTECTION	FUSE	40A*12	40A*6	20A*6	40A*12	40A*6	20A*6
	BAT. LOW ALARM Note.6	11.3V	22.5V	45V	11.3V	22.5V	45V
	BAT. LOW SHUTDOWN Note.6	10.5V	21V	42V	10.5V	21V	42V
	REVERSE POLARITY	By internal fuse open					
OUTPUT PROTECTION	OVER TEMPERATURE	90°C ± 5°C	85°C ± 5°C	85°C ± 5°C	80°C ± 5°C	75°C ± 5°C	75°C ± 5°C
	OUTPUT SHORT	Protection type : Shut down o/p voltage, re-power on to recover					
	OVER LOAD (Typ.)	105 ~ 115% load for 180 sec., 115% ~ 150% load for 10 sec.					
		Protection type : Shut down o/p voltage, re-power on to recover					
	CIRCUIT BREAKER	AC output: 40A, AC receptacle:15A			AC output: 20A, AC receptacle: 15A		
GFCI PROTECTION	Optional (Only type F)			None			
ENVIRONMENT	WORKING TEMP. Note.2	0 ~ +40°C @ 100% load ; 60°C @ 50% load					
	WORKING HUMIDITY	20% ~ 90% RH non-condensing					
	STORAGE TEMP., HUMIDITY	-30 ~ +70°C / -22 ~ +158°F, 10 ~ 95% RH non-condensing					
	VIBRATION	10 ~ 500Hz, 3G 10min./1cycle, 60min. each along X, Y, Z axes					
SAFETY & EMC	SAFETY STANDARDS	UL458 (only for Type G), EAC TP TC 004		EAC TP TC 004	IEC62368-1 CB, EAC TP TC 004 approved; Design refer to BS EN/EN62368-1		
	WITHSTAND VOLTAGE	Bat I/P - AC I/P:3.0KVAC Bat I/P - AC O/P:3.0KVAC AC O/P - FG:1.5KVAC					
	ISOLATION RESISTANCE	Bat I/P - AC O/P, Bat I/P - FG, AC O/P - FG: 100M ohms / 500VDC / 25°C / 70% RH					
	EMC EMISSION	Compliance to FCC class A, EAC TP TC 020			Compliance to BS EN/EN55032 class A, 72/245/CEE, 95/54/CE, E-Mark, EAC TP TC 020		
EMC IMMUNITY	Compliance to EAC TP TC 020			Compliance to BS EN/EN61000-4-2,3,4,5,6,8,11, EAC TP TC 020			
AC CHARGER	CHARGE CURRENT (Typ.)	25A	12A	6A	25A	12A	6A
	CHARGE VOLTAGE Note.6	14.3V	28.5V	57V	14.3V	28.5V	57V
SOLAR PANEL	MAX OPEN CIRCUIT VOLTAGE	25V	45V	75V	25V	45V	75V
	SHORT CIRCUIT CURRENT (max.)	30A					
OTHERS	CONTROL WIRING Note.7	RJ11 -RS232					
	DIMENSION	466.8*283.5*100mm (L*W*H)					
	PACKING	12.9Kg; 1pcs/14Kg/1.49CUFT					
NOTE	<p>1.Efficiency is tested by 2100W, linear load at 13V, 26V, 52V input voltage. 2.Output derating capacity referenced by curve 1. 3.Input derating capacity referenced by curve 2. 4.DC current is tested by 3000W, linear load at 12V, 24V, 48V input voltage. 5.All parameters not specified above are measured at rated load, 25°C of ambient temperature and set to factory setting. 6.The tolerance of each voltage value by models is:112/212→±0.5V;124/224→±1V;148/248→±2V. 7.The cable is enclosed for the connection between TN-3000 and computer for software monitoring. 8.THd is tested by 3000W, linear load at 13,26,52V input voltage. 9.Please do not turn on the inverter before start the engine if inverter connect to vehicle's battery directly. 10.The ambient temperature derating of 3.5°C/1000m with fanless models and of 5°C/1000m with fan models for operating altitude higher than 2000m(6500ft). 11.Type F for 60Hz only. ※ Product Liability Disclaimer : For detailed information, please refer to https://www.meanwell.com/serviceDisclaimer.aspx</p>						

■ Instructions for TN-3000 monitoring software

1. The monitoring software can be downloaded from product section (with TN-3000 specification) on MEAN WELL's official website, <http://www.meanwell.com/productsoftware.aspx>
2. The monitoring software can run on Windows 7 English version, Windows 7 Chinese (Traditional, Taiwan) version, Windows 8 English version and Windows 8 Chinese (Traditional, Taiwan) version
3. Installation of TN-3000 unit and PC

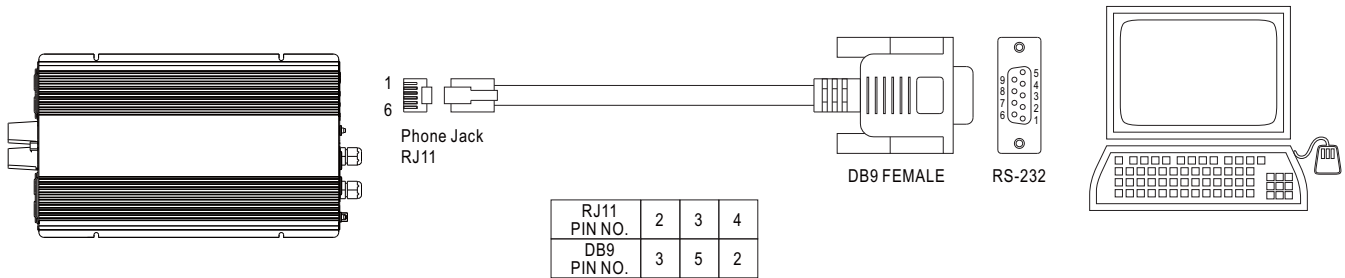

Figure 1

4. Explanation of Monitoring Manu

4.1 Main Page

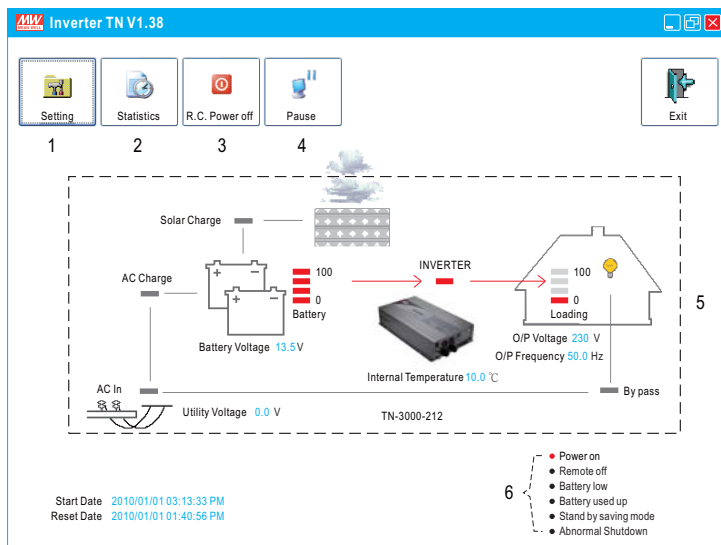
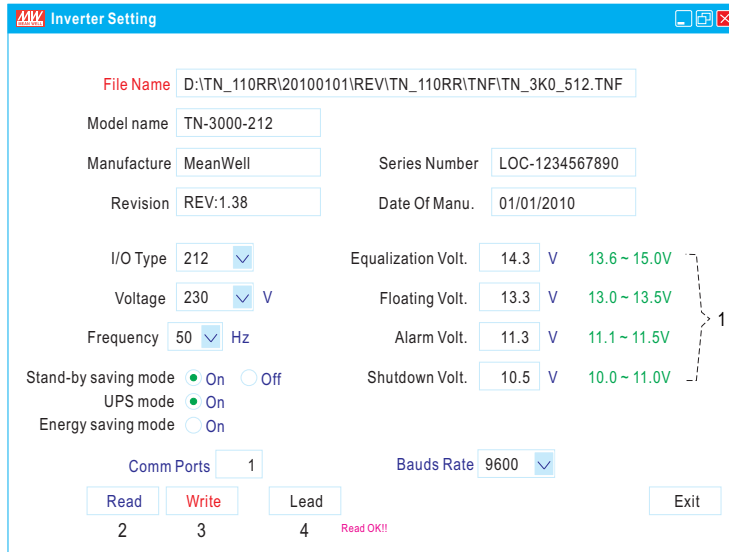

Figure 2

1. Setting: Adjustment for output voltage, charging related voltage, frequency, and operation mode. Please refer to Figure 3 for details.
2. Statistics: Calculate for the percentage of operating period for each operation mode. Please refer to Figure 4 for details.
3. R.C. Power off: Power can be turned ON or OFF at the remote location.
4. Pause: Stop refreshing the page of monitoring software.
5. Status of unit: Indicating current operating status of TN-3000.
6. Signals that display current condition of the unit.

4.2 Setting Page



File Name: D:\TN_110RR\20100101\REV\TN_110RR\TNF\TN_3K0_512.TNF

Model name: TN-3000-212

Manufacture: MeanWell Series Number: LOC-1234567890

Revision: REV:1.38 Date Of Manu.: 01/01/2010

I/O Type: 212 Equalization Volt.: 14.3 V 13.6 ~ 15.0V

Voltage: 230 V Floating Volt.: 13.3 V 13.0 ~ 13.5V

Frequency: 50 Hz Alarm Volt.: 11.3 V 11.1 ~ 11.5V

Stand-by saving mode: On Off Shutdown Volt.: 10.5 V 10.0 ~ 11.0V

UPS mode: On

Energy saving mode: On

Comm Ports: 1 Bauds Rate: 9600

Buttons: Read (2), Write (3), Lead (4), Exit

Figure 3

1. User can adjust the settings based on the characteristics of batteries been used: Equalization Voltage, Floating Voltage, Alarm Voltage, and Shut-down Voltage. UPS Mode / Energy Saving Mode selection and AC output voltage and frequency can also be set in this page.
2. Read: Read current settings of the unit.
3. Write: Write the revised setting into the unit.
4. Load: Load in factory default settings.

4.3 Statistic Page

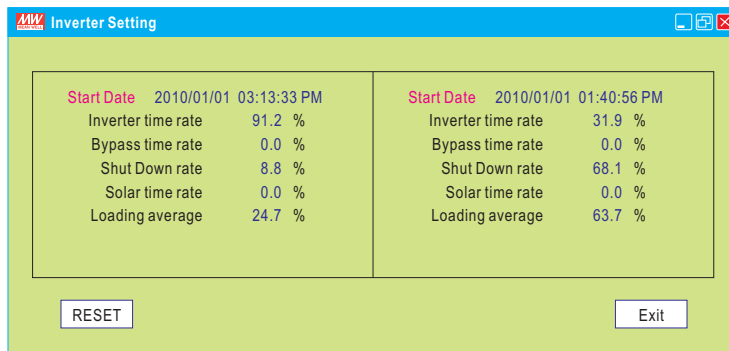

Start Date	2010/01/01 03:13:33 PM	Start Date	2010/01/01 01:40:56 PM
Inverter time rate	91.2 %	Inverter time rate	31.9 %
Bypass time rate	0.0 %	Bypass time rate	0.0 %
Shut Down rate	8.8 %	Shut Down rate	68.1 %
Solar time rate	0.0 %	Solar time rate	0.0 %
Loading average	24.7 %	Loading average	63.7 %

Buttons: RESET, Exit

Figure 4

1. Start Date: Date that installing the monitoring software.
2. Reset Date: Date that resetting the statistics. The Start Date will not be influenced by resetting the statistics or turning off the unit.
3. Inverter time rate: Operating period of "Inverter Mode" represents how many percent of the whole operating period.
4. Bypass time rate: Operating period of "Bypass Mode" (energy provides directly by the utility) represents how many percent of the whole operating period.
5. Shut down rate: Percentage of time period that the unit is under the condition of shut down.
* Inverter time rate + Bypass time rate + Shut down rate = 100%
6. Solar time rate: Percentage of time period that the solar charger is functioning after turning on the TN-3000 unit.
7. Loading average: Average loading after turning on the TN-3000 unit.

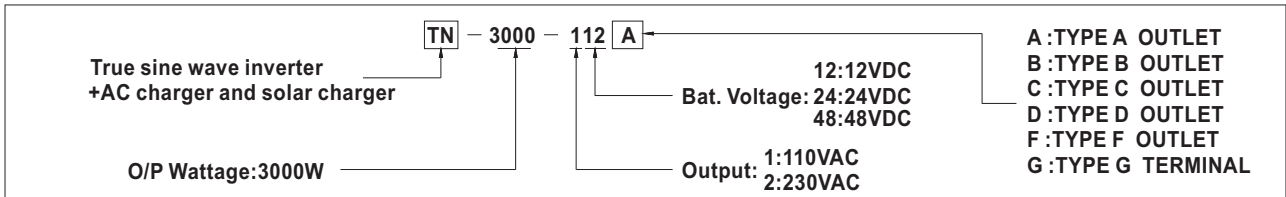

■ AC Output Socket (optional)

MODEL NO.	TN-3000-112 <input type="checkbox"/>	TN-3000-124 <input type="checkbox"/>	TN-3000-148 <input type="checkbox"/>	TN-3000-212 <input type="checkbox"/>	TN-3000-224 <input type="checkbox"/>	TN-3000-248 <input type="checkbox"/>	
Socket type			 (Terminal inside case only, no AC socket)				 (Terminal inside case only, no AC socket)
	TYPE-A	TYPE-F	TYPE-G	TYPE-B	TYPE-C	TYPE-D	TYPE-G
	Standard	Optional	Optional	Standard	Optional	Optional	Optional
Country	USA	GFCI (60Hz)	----	EUROPE	AUSTRALIA	U.K	----
Certificate			 (Except for 48V input)				None

■ Mechanical Specification

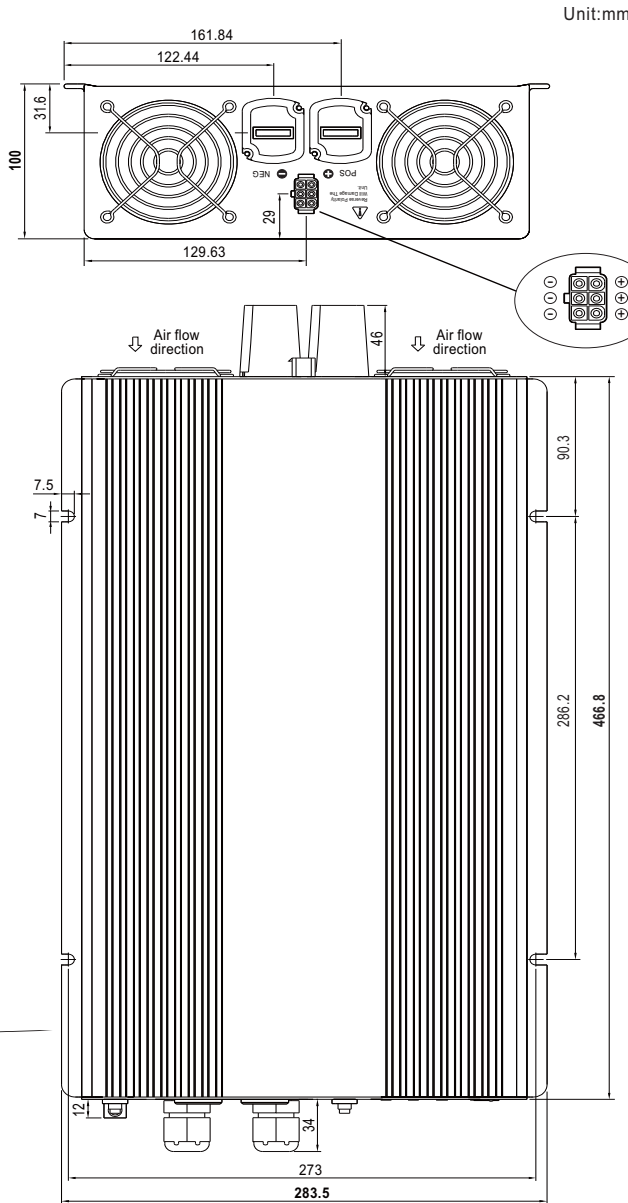

■ Derating Curve

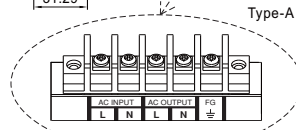
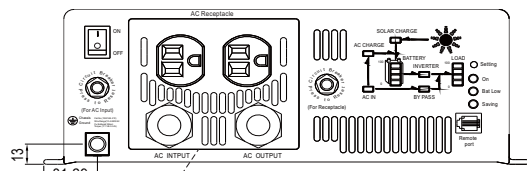
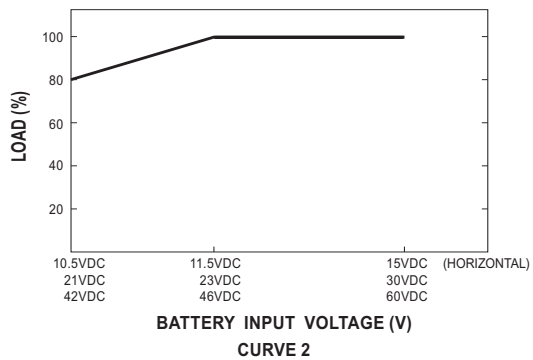
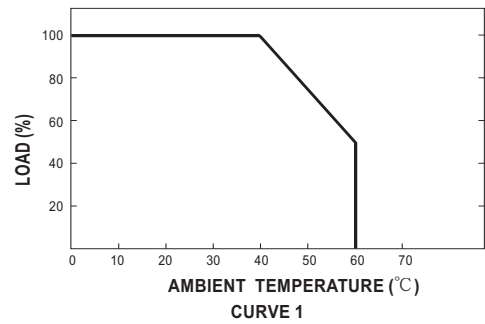

Note: When the load current is >15A, must use output terminal connection which can be found inside the AC output panel of the inverter.

