



■ Features

- DIP 1"x1" package with industry standard pinout
- 4:1 ultrawide input range
- Operating temperature range -40 ~ +85°C
- No minimum load required
- Comply to EN55032 radiated Class A without additional components
- High efficiency up to 89%
- Protections: Short circuit (Continuous) / Overload / Over voltage / Input under voltage
- 3KVDC I/O isolation
- 3 years warranty

■ Applications

- Telecom/datacom system
- Wireless network
- Industrial control facility
- Instrument
- Analyzer
- Detector
- Data switch

■ Description

SKMW15 and DKMW15 series are 15W isolated and regulated module type DC-DC converter with DIP 1"x1" package. It features international standard pins, a high efficiency up to 89%, wide working temperature range -40~+85°C, 3KVDC I/P-O/P isolation voltage, compliance to EN55032 radiated Class A without additional components, continuous-mode short circuit, overload, input under voltage protection etc. The models account for different input voltage 9~36V and 18~75V 4:1 ultrawide input range, and various output voltage, 3.3V/5V/12V/15V for single output and ±5V/±12V/±15V for dual outputs, which are suitable for all kinds of systems, Such as industrial control, telecommunication field, distributed power architecture, and so on.

■ Model Encoding

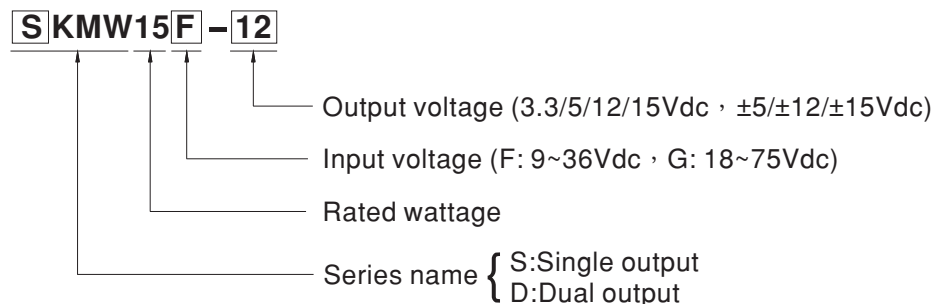

File Name:SKMW15,DKMW15-SPEC 2021-03-1

MODEL SELECTION TABLE

ORDER NO.	INPUT			OUTPUT		EFFICIENCY (TYP.)	CAPACITOR LOAD (MAX.)
	INPUT VOLTAGE (RANGE)	INPUT CURRENT		OUTPUT VOLTAGE	OUTPUT CURRENT		
		NO LOAD	FULL LOAD				
SKMW15F-03	Normal 24V (9 ~ 36V)	70mA	500mA	3.3V	0~3000mA	85%	820μF
SKMW15F-05		80mA	730mA	5V	0~3000mA	85%	820μF
SKMW15F-12		30mA	710mA	12V	0~1250mA	89%	220μF
SKMW15F-15		30mA	720mA	15V	0~1000mA	87%	120μF
DKMW15F-05		35mA	750mA	±5V	±0~1500mA	85%	*1000μF
DKMW15F-12		35mA	730mA	±12V	±0~625mA	88%	*470μF
DKMW15F-15		35mA	700mA	±15V	±0~500mA	89%	*330μF
SKMW15G-03		Normal 48V (18 ~ 75V)	70mA	255mA	3.3V	0~3000mA	85%
SKMW15G-05	80mA		365mA	5V	0~3000mA	86%	820μF
SKMW15G-12	30mA		355mA	12V	0~1250mA	89%	220μF
SKMW15G-15	30mA		360mA	15V	0~1000mA	88%	120μF
DKMW15G-05	25mA		380mA	±5V	±0~1500mA	86%	*1000μF
DKMW15G-12	25mA		360mA	±12V	±0~625mA	88%	*470μF
DKMW15G-15	25mA		360mA	±15V	±0~500mA	89%	*330μF

* For each output

SPECIFICATION				
INPUT	VOLTAGE RANGE	F: 9~36Vdc , G: 18~75Vdc		
	FILTER	Pi type		
	PROTECTION	Fuse recommended. 24Vin models: 4.0A delay time Type, 48Vin models: 2.0A delay time Type		
OUTPUT	VOLTAGE ACCURACY	±2%		
	RATED POWER	10W for 3.3V output ; 15W for other output		
	RIPPLE & NOISE <small>Note.2</small>	50mVp-p(max.)		
	LINE REGULATION <small>Note.3</small>	±0.5%		
	LOAD REGULATION <small>Note.4</small>	±0.5%		
	SWITCHING FREQUENCY (Typ.)	300KHz		
	EXTERNAL TRIM ADJ. RANGE (Typ.)	Single output only; ± 10% for 3.3V/5V, -20%~+10% for 12V/15V		
PROTECTION	SHORT CIRCUIT	Protection type : Continuous, automatic recovery		
	OVERLOAD	110 ~ 220% rated output power Protection type : Recovers automatically after fault condition is removed		
	OVER VOLTAGE	Protection type : Clamp by diode for single output ; Hiccup mode for dual output		
	UNDER VOLTAGE LOCKOUT	Start-up voltage	24Vin (F-type): 9.0Vdc, 48Vin (G-type): 17.3Vdc	
Shutdown voltage		24Vin (F-type): 8.6Vdc, 48Vin (G-type): 16.5Vdc		
FUNCTION	REMOTE CONTROL	Power ON: R.C. ~ -Vin >2.5Vdc or open circuit ; Power OFF: R.C. ~ -Vin <0.5Vdc or short		
ENVIRONMENT	COOLING	Free-air convection		
	WORKING TEMP.	-40 ~ +85°C (Refer to "Derating Curve")		
	CASE TEMPERATURE	+110°C max.		
	WORKING HUMIDITY	5% ~ 95% RH non-condensing		
	STORAGE TEMP., HUMIDITY	-55 ~ +125°C, 10 ~ 95% RH non-condensing		
	TEMP. COEFFICIENT	0.03% / °C (0 ~ 71°C)		
	SOLDERING TEMPERATURE	1.5mm from case of 3 ~ 5sec./265°C (max.)		
	VIBRATION	10 ~ 500Hz, 2G 10min./1cycle, period for 60min. each along X, Y, Z axes		
SAFETY & EMC (Note.5)	SAFETY STANDARDS	EAC TP TC 004 approved		
	WITHSTAND VOLTAGE	I/P-O/P:3KVDC		
	ISOLATION RESISTANCE	I/P-O/P:100M Ohms / 500VDC / 25°C / 70% RH		
	ISOLATION CAPACITANCE (Typ.)	1200pF		
	EMC EMISSION	Parameter	Standard	Test Level / Note
		Conducted	EN55032(CISPR32)	N/A
		Radiated	EN55032(CISPR32)	Class A without external components Class B with external components
	EMC IMMUNITY	Parameter	Standard	Test Level / Note
		ESD	EN61000-4-2	contact ±4KV
		Radiated Susceptibility	EN61000-4-3	3V/m
EFT/Burest		EN61000-4-4	±0.5KV(see page 5)	
Surge		EN61000-4-5	Line-Line±0.5KV	
Conducted	EN61000-4-6	3Vrms		
OTHERS	MTBF	220Khrs MIL-HDBK-217F(25°C)		
	DIMENSION (L*W*H)	25.4*25.4*10.2mm (1*1*0.4 inch)		
	CASE MATERIAL	Black coated metal with non-conductive base		
	PACKING	20g; 10pcs/per tube, 600pcs/60 tube/per carton		
NOTE	<p>1.All parameters are specified at normal input, rated load, 25°C 70% RH ambient. 2.Ripple & noise are measured at 20MHz by using a 12" twisted pair terminated with a 0.1µf & 47µf capacitor. 3.Line regulation is measured from low line to high line at rated load. 4.Load regulation is measured from 10% to 100% rated load. 5.The final equipment must be re-confirm that it still meet EMC directives. For guidance on how to perform these EMC tests, please refer to "EMI testing of component power supplies."(as available on http://www.meanwell.com) ※ Product Liability Disclaimer : For detailed information, please refer to https://www.meanwell.com/serviceDisclaimer.aspx</p>			

External Output Trimming

In order to trim the voltage up or down one needs to connect the trim resistor either between the trim pin and -Vo for trim-up and between trim pin and +Vo for trim-down. This is shown in Figures 1 and 2:

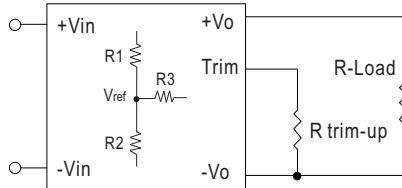

Figure 1. Trim-up Voltage Setup

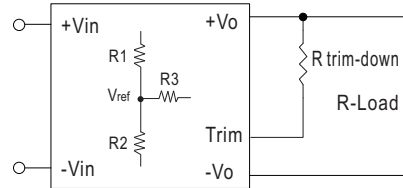

Figure 2. Trim-down Voltage Setup

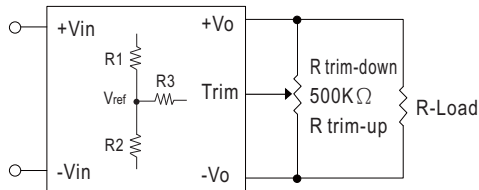

Figure 3. Trim-Connections

Table 1 – Trim up and Trim down Resistor Values

Vout	R1(KΩ)	R2(KΩ)	R3(KΩ)	Vref
3.3	1.69	1	5.6	1.25
5	1	1	3.6	2.5
12	3.83	1	7.5	2.5
15	7.5	1.5	11	2.5

1. The value of Rtrim-up defined as:

$$A = [V_{ref} / (V_o' - V_{ref})] * R1$$

$$R_{trim-up} = [(A * R2) / (R2 - A)] - R3$$

Where

R_{trim-up} is the external resistor in Kohm.

V_{o, nom} is the nominal output voltage.

V_{o'} is the desired output voltage.

R1, R2, R3 and V_{ref} are internal to the unit and defined in Table 1.

For example, to trim-up the output voltage of 12V model (SKMW15F-12) by 10% to 13.2V, R_{trim-up} is calculated as follows:

$$V_o' - V_{o, nom} = 13.2V - 12V = 1.2V$$

$$R1 = 3.83 K\Omega$$

$$R2 = 1 K\Omega$$

$$R3 = 7.5 K\Omega$$

$$V_{ref} = 2.5V$$

$$A = [V_{ref} / (V_o' - V_{ref})] * R1$$

$$= [2.5 / (13.2 - 2.5)] * 3.83$$

$$= 0.894$$

$$R_{trim-up} = [(A * R2) / (R2 - A)] - R3$$

$$= [(0.894 * 1) / (1 - 0.894)] - 7.5$$

$$= (0.894 / 0.106) - 7.5$$

$$= 8.433 - 7.5$$

$$= 0.933 K\Omega$$

2. The value of R_{trim-down} defined as:

$$A = [(V_o' - V_{ref}) / V_{ref}] * R_2$$

$$R_{trim-down} = [(A * R_1) / (R_1 - A)] - R_3$$

Where

R_{trim-down} is the external resistor in Kohm.

V_{o, nom} is the nominal output voltage.

V_{o'} is the desired output voltage.

R₁, R₂, R₃ and V_{ref} are internal to the unit and defined in Table 1.

For example, to trim-down the output voltage of 12V model (SKMW15F-12) by 10% to 10.8V, R_{trim-down} is calculated as follows:

$$V_{o,nom} - V_o' = 12V - 10.8V = 1.2V$$

$$R_1 = 3.83 \text{ K}\Omega$$

$$R_2 = 1 \text{ K}\Omega$$

$$R_3 = 7.5 \text{ K}\Omega$$

$$V_{ref} = 2.5V$$

$$A = [(V_o' - V_{ref}) / V_{ref}] * R_2$$

$$= [(10.8 - 2.5) / 2.5] * 1$$

$$= 3.32$$

$$R_{trim-down} = [(A * R_1) / (R_1 - A)] - R_3$$

$$= [(3.32 * 3.83) / (3.83 - 3.32)] - 7.5$$

$$= (12.715 / 0.51) - 7.5$$

$$= 24.931 - 7.5$$

$$= 17.431 \text{ K}\Omega$$

Mechanical Specification

- All dimensions in mm (inch)
- Tolerance: $x.x \pm 1\text{mm}$ ($x.xx \pm 0.04"$)
- Pin size is $1 \pm 0.1\text{mm}$ ($0.04" \pm 0.004"$)

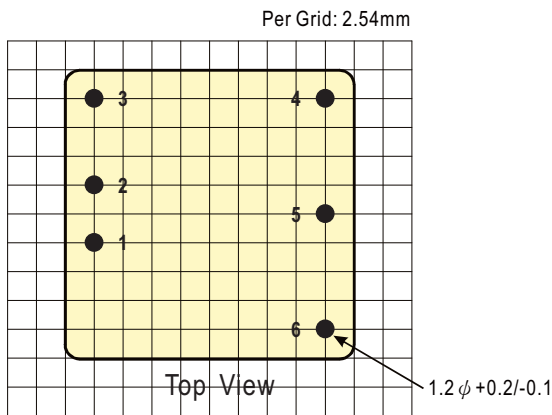
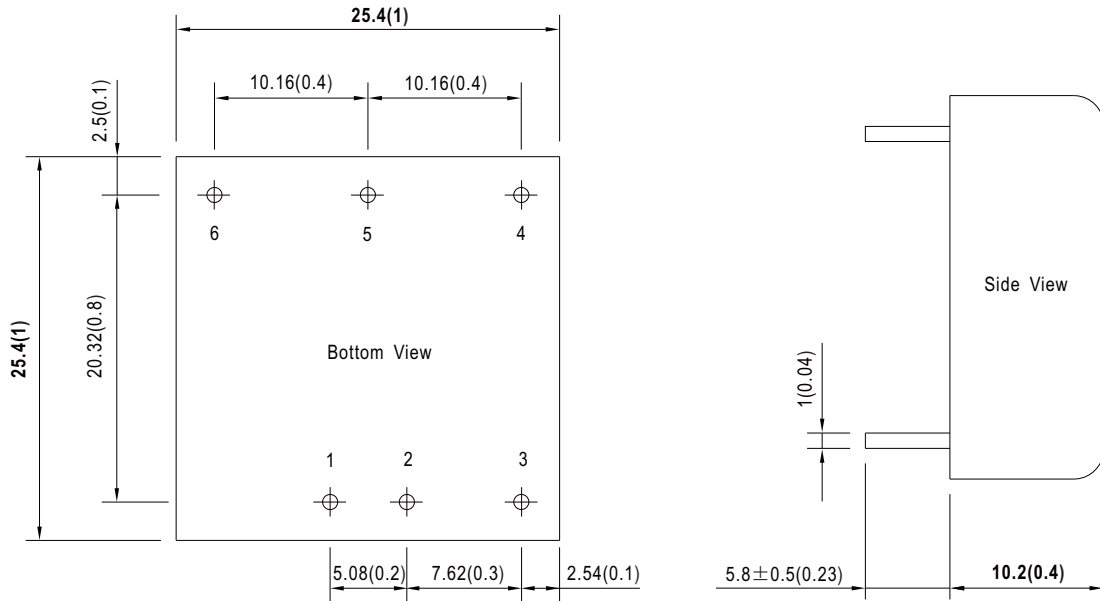

Plug Assignment

Pin-Out		
Pin No.	SKMW15 (Single output)	DKMW15 (Dual output)
1	+Vin	+Vin
2	-Vin	-Vin
3	Remote On/Off	
4	-Vout	-Vout
5	Trim	Common
6	+Vout	+Vout

Derating Curve

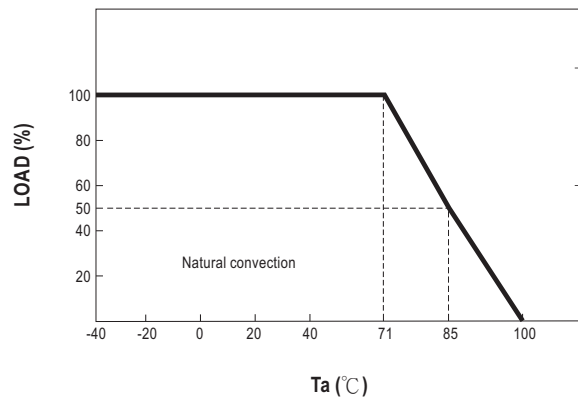

■ EMC Suggest Circuit

* Required external componets to meet EN55032 radiated Class B emission as below:

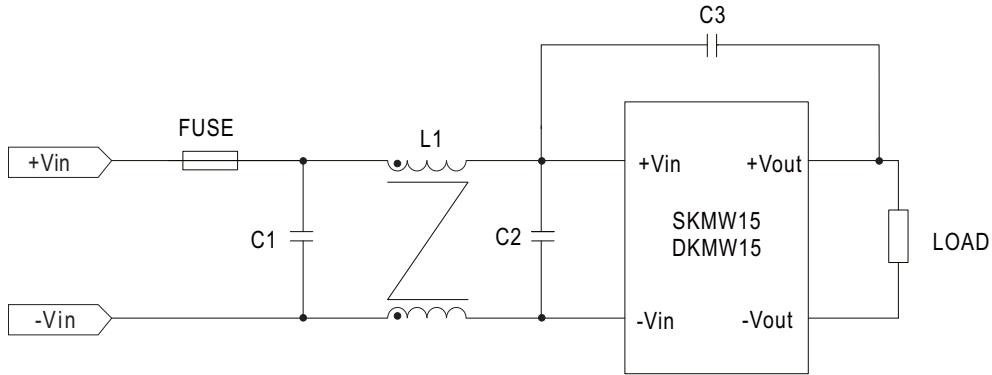

Model	EN55032 Class B	
	Vin:24V	Vin:48V
C1	4.7 μ F/50V MLCC	2.2 μ F/100V MLCC
C2	4.7 μ F/50V MLCC	2.2 μ F/100V MLCC
C3	1000pF/3KV MLCC	1000pF/3KV MLCC
L1	325 μ H Common Choke	325 μ H Common Choke