

# 18W Desktop C14 Adapter Series

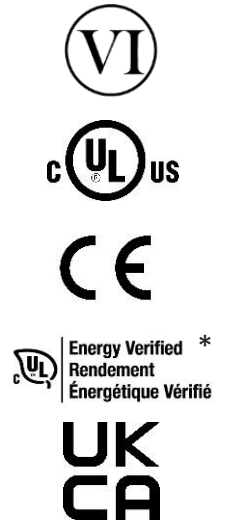

## Features

- DOE Level VI Efficiency Compliant
- ErP/Ecodesign Directive 2009/125/EC – Regulation EU 2019/1782 Compliant
- EU CoC Tier 2 Compliant (except 5V, 5.9V, 10V, 11V models)
- Over Voltage, Short Circuit and Over Current Protection
- Non-Vented/Spill-Proof Case
- Class B EMI

## Applications

- Networking
- Peripherals
- Consumer Electronics

\*NRCAN approval for PPL18U-050L6, PPL18U-060L6, PPL18U-090, PPL18U-120, PPL18U-150, PPL18U-180, PPL18U-240 models only

# PPL18U Series Specifications<sup>1</sup>

Model		PPL18U-050L6*	PPL18U-060L6*	PPL18U-070	PPL18U-075
Output	DC Output Voltage	5.0V	5.9V	7.0V	7.5V
	Max Current	3.0A	3.0A	2.5A	2.5A
	Output Power	15.0W	17.7W	17.5W	18.75W
	Regulation	± 6%	-3.4/+6.8%	± 5%	± 5%
	Ripple & Noise P-P(max) <sup>2</sup>	100mV	100mV	100mV	100mV
Input	AC Input Voltage Range	90 to 264VAC			
	AC Input Frequency	47 to 63Hz			
	Input Current	0.48A max			
	Inrush Current	50A max., 100VAC; 60A max., 230VAC			
	No Load Power Consumption at 115VAC Input	0.035W	0.045W	0.040W	0.043W
	No Load Power Consumption at 230VAC Input	0.051W	0.056W	0.047W	0.053W
	115VAC Average Efficiency <sup>3</sup>	82.0%	82.6%	86.1%	86.3%
	230VAC Average Efficiency <sup>3</sup>	81.8%	83.3%	86.1%	86.4%
	230VAC 10% Load Efficiency <sup>3</sup>	76.0%	76.5%	83.5%	83.4%
	Leakage Current	<3.5A			
Protection	Over-Voltage	12V max	12V max	16V max	16V max
	Short Circuit	Auto-recover after short-circuit fault is removed			
	Over-Current	7A max	6A max	6A max	6A max
Environmental	Operating Temperature	0°C to +40°C			
	Non-Operating Temperature	-20° to +80°C			
	Operating Humidity	20 to +80%			
Safety Approvals and EMC	Dielectric Withstand (HI-POT)	Primary to Secondary: 3000VAC for 1min, 10mA			
	Insulation Resistance	Primary to Secondary: 10M ohm for 500VDC			
	Standards	cULus 62368-1, IEC 62368-1			
	EMI Emissions	FCC Part 15 Class B, CAN ICES-003(B)/NMB-003(B), EN 55032/CISPR 32 Class B Conducted and Radiated			
	Harmonic Current Emissions	IEC 61000-3-2			
	Voltage Fluctuations & Flicker	IEC 61000-3-3			
	Immunity	EN 55035/CISPR 35: IEC 61000-4-2, IEC 61000-4-3, IEC 61000-4-4, IEC 61000-4-5, IEC 61000-4-6, IEC 61000-4-8, IEC 61000-4-11			
Mechanical	Dimensions (L x W x H)	100mm (3.94in) x 50mm (1.97in) x 33mm (1.3in)			
	Weight	170g			
	Cable Length	1500mm			
	DC Cable Type	18 AWG	18 AWG	18 AWG	18 AWG
	DC Output Connector	2.1mm x 5.5mm x 10.0mm			
	DC Plug Pin Assignment	Inner (V+) / Outer GND (V-)			
	Input Connector	IEC 60320 C14			

Model		PPL18U-090*	PPL18U-100L6	PPL18U-110L6	PPL18U-120*
Output	DC Output Voltage	9.0V	10.0V	11.0V	12.0V
	Max Current	2.2A	1.9A	1.6A	1.6A
	Output Power	19.8W	19.0W	17.6W	19.2W
	Regulation	± 5%	± 5%	± 5%	± 5%
	Ripple & Noise P-P(max) <sup>2</sup>	100mV	100mV	110mV	120mV
Input	AC Input Voltage Range	90 to 264VAC			
	AC Input Frequency	47 to 63Hz			
	Input Current	0.48A max			
	Inrush Current	50A max., 100VAC; 60A max., 230VAC			
	No Load Power Consumption at 115VAC Input	0.039W	0.038W	0.041W	0.045W
	No Load Power Consumption at 230VAC Input	0.055W	0.067W	0.065W	0.064W
	115VAC Average Efficiency <sup>3</sup>	86.3%	86.2%	85.8%	86.2%
	230VAC Average Efficiency <sup>3</sup>	86.7%	85.7%	85.6%	86.4%
	230VAC 10% Load Efficiency <sup>3</sup>	80.3%	82.0%	81.0%	80.3%
	Leakage Current	<3.5A			
Protection	Over-Voltage	16V max	22V max	22V max	22V max
	Short Circuit	Auto-recover after short-circuit fault is removed			
	Over-Current	5A max	5A max	5A max	5A max
Environmental	Operating Temperature	0°C to +40°C			
	Non-Operating Temperature	-20° to +80°C			
	Operating Humidity	20 to +80%			
Safety Approvals and EMC	Dielectric Withstand (HI-POT)	Primary to Secondary: 3000VAC for 1min, 10mA			
	Insulation Resistance	Primary to Secondary: 10M ohm for 500VDC			
	Standards	cULus 62368-1, IEC 62368-1			
	EMI Emissions	FCC Part 15 Class B, CAN ICES-003(B)/NMB-003(B), EN 55032/CISPR 32 Class B Conducted and Radiated			
	Harmonic Current Emissions	IEC 61000-3-2			
	Voltage Fluctuations & Flicker	IEC 61000-3-3			
	Immunity	EN 55035/CISPR 35: IEC 61000-4-2, IEC 61000-4-3, IEC 61000-4-4, IEC 61000-4-5, IEC 61000-4-6, IEC 61000-4-8, IEC 61000-4-11			
Mechanical	Dimensions (L x W x H)	100mm (3.94in) x 50mm (1.97in) x 33mm (1.3in)			
	Weight	170g			
	Cable Length	1500mm			
	DC Cable Type	18 AWG	22 AWG	22 AWG	20 AWG
	DC Output Connector	2.1mm x 5.5mm x 10.0mm			
	DC Plug Pin Assignment	Inner (V+) / Outer GND (V-)			
	Input Connector	IEC 60320 C14			

Model		PPL18U-150*	PPL18U-160	PPL18U-180*	PPL18U-240*
Output	DC Output Voltage	15.0V	16.0V	18.0V	24.0V
	Max Current	1.3A	1.2A	1.1A	0.8A
	Output Power	19.5W	19.2W	19.8W	19.2W
	Regulation	± 5%	± 5%	± 5%	± 5%
	Ripple & Noise P-P(max) <sup>2</sup>	150mV	160mV	180mV	240mV
Input	AC Input Voltage Range	90 to 264VAC			
	AC Input Frequency	47 to 63Hz			
	Input Current	0.48A max			
	Inrush Current	50A max., 100VAC; 60A max., 230VAC			
	No Load Power Consumption at 115VAC Input	0.036W	0.035W	0.045W	0.036W
	No Load Power Consumption at 230VAC Input	0.055W	0.066W	0.064W	0.057W
	115VAC Average Efficiency <sup>3</sup>	87.4%	87.8%	88.1%	88.9%
	230VAC Average Efficiency <sup>3</sup>	87.1%	87.4%	88.4%	88.7%
	230VAC 10% Load Efficiency <sup>3</sup>	82.7%	82.5%	81.9%	81.8%
	Leakage Current	<3.5A			
Protection	Over-Voltage	32V max	32V max	32V max	45V max
	Short Circuit	Auto-recover after short-circuit fault is removed			
	Over-Current	4A max	4A max	4A max	2.5A max
Environmental	Operating Temperature	0°C to +40°C			
	Non-Operating Temperature	-20° to +80°C			
	Operating Humidity	20 to +80%			
Safety Approvals and EMC	Dielectric Withstand (HI-POT)	Primary to Secondary: 3000VAC for 1min, 10mA			
	Insulation Resistance	Primary to Secondary: 10M ohm for 500VDC			
	Standards	cULus 62368-1, IEC 62368-1			
	EMI Emissions	FCC Part 15 Class B, CAN ICES-003(B)/NMB-003(B), EN 55032/CISPR 32 Class B Conducted and Radiated			
	Harmonic Current Emissions	IEC 61000-3-2			
	Voltage Fluctuations & Flicker	IEC 61000-3-3			
	Immunity	EN 55035/CISPR 35: IEC 61000-4-2, IEC 61000-4-3, IEC 61000-4-4, IEC 61000-4-5, IEC 61000-4-6, IEC 61000-4-8, IEC 61000-4-11			
Mechanical	Dimensions (L x W x H)	100mm (3.94in) x 50mm (1.97in) x 33mm (1.3in)			
	Weight	170g			
	Cable Length	1500mm			
	DC Cable Type	22 AWG	22 AWG	22 AWG	22 AWG
	DC Output Connector	2.1mm x 5.5mm x 10.0mm			
	DC Plug Pin Assignment	Inner (V+) / Outer GND (V-)			
	Input Connector	IEC 60320 C14			
Notes	1. The specifications defined are at ambient temperature of 25C, unless otherwise specified. 2. 20MHz bandwidth frequency oscilloscope, add a 0.1µF multilayer Cap. and Low ESR Electrolytic Cap. (10µF) at output connector terminals (nominal line voltage, full load). 3. Efficiency is measured after 30 minutes burn-in.				

# PPL18U Outline Drawing

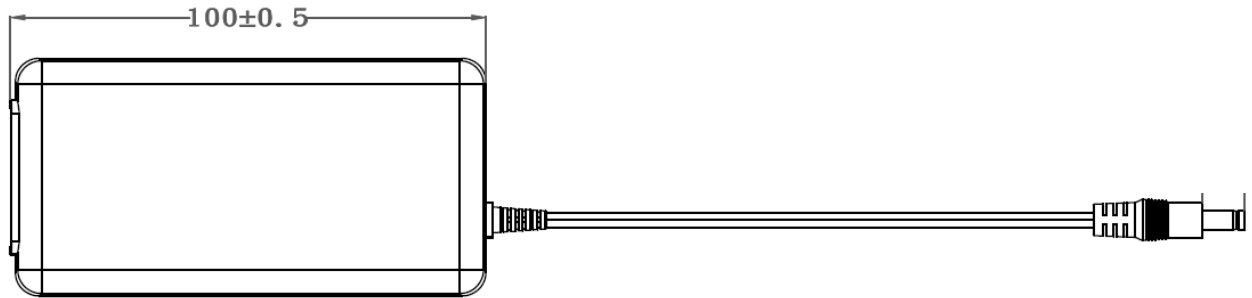

TOP VIEW

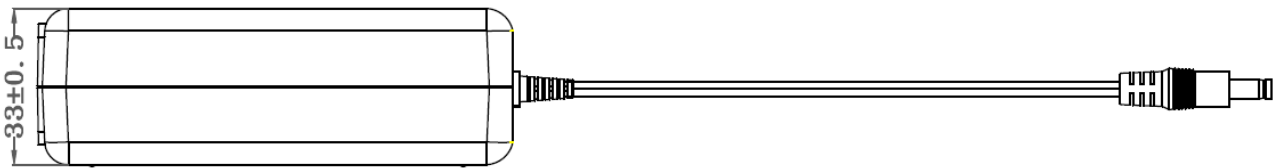

SIDE VIEW

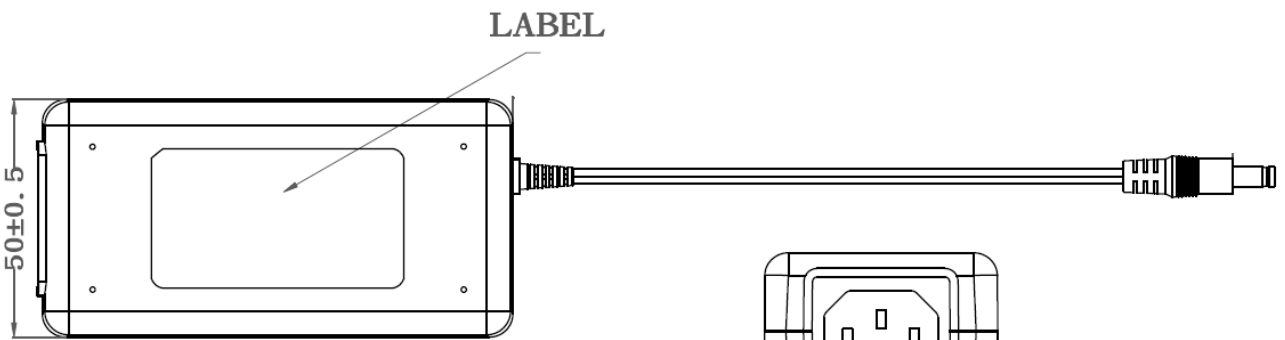

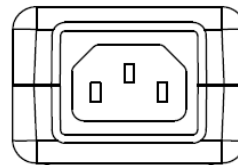

BOTTOM VIEW



FRONT-VIEW

# PPL18U Line Cords Sold Separately

Model		AC30UNA-R	AC30UEU-R	AC30UUK-R
Specifications	Plug Type	North America NEMA 5-15P	Continental Europe CEE 7VIII	United Kingdom BS 1363
	Connector	IEC320 C13	IEC320 C13	IEC320 C13
	Wire Size	18 AWG	0.75mm	1.0mm
	Temperature	60°C	70°C	70 °C
	Amperage Rating	10A	6A	10A
	Voltage Rating	125V	250V	250V
	Cable Length	1830mm	1830mm	2500mm
Safety Approvals		CSA; UL	CEBEC; DEMKO; DVE; FIMKO; GOST; IMQ; KEMA; NEMKO; NF; OVE; SEMKO	BSI; Safety Mark
Photos				

# PPL18U Line Cords Outline Drawings

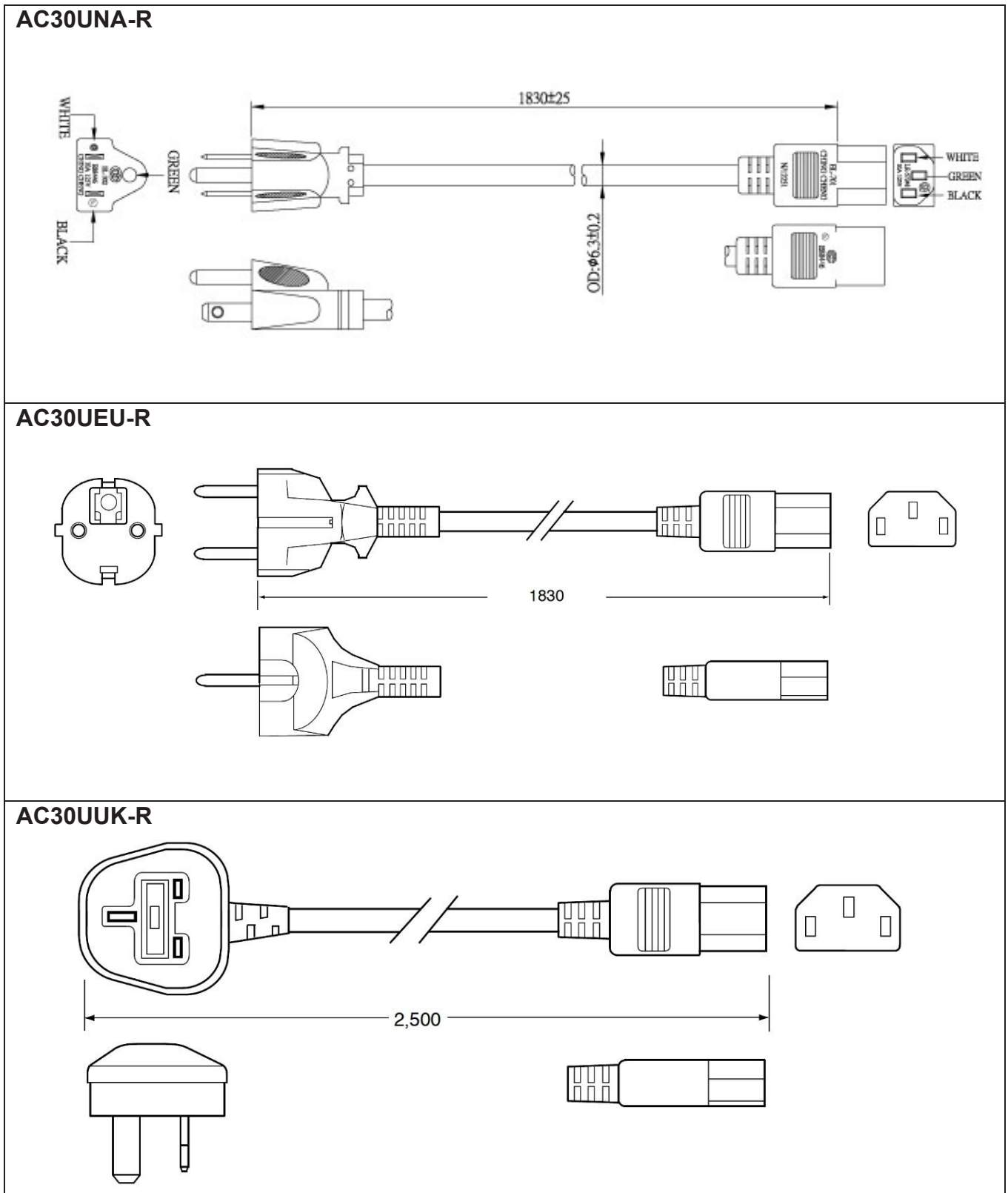

Revised 2/27/2023