

■ Features

- AC input range selectable by switch
- Withstand 300VAC surge input for 5 second
- Up to 200% peak power capability
- Protections: Short circuit / Overload / Over voltage / Over temperature
- Cooling by free air convection
- 1U low profile
- Withstand 5G vibration test
- LED indicator for power on
- No load power consumption < 1W
- High operating temperature up to 70°C
- Operating altitude up to 5000 meters
- High efficiency, long life and high reliability
- 3 years warranty

■ Applications

- Industrial automation machinery
- Industrial control system
- Mechanical and electrical equipment
- Electronic instruments, equipments or apparatus

■ Description

LRS-200N2 series is a 200W single-output enclosed type power supply with 30mm of low profile design. Adopting the input of 115VAC or 230VAC (select by switch), the entire series provides an output voltage line of 12V, 24V, 36V and 48V. In addition to the high efficiency up to 90%, the design of metallic mesh case enhances the heat dissipation of LRS-200N2 that the whole series operates from -25°C through 70°C under air convection without a fan. Delivering an extremely low no load power consumption (less than 0.75W), it allows the end system to easily meet the worldwide energy requirement. LRS-200N2 has the complete protection functions and 5G anti-vibration capability; it is complied with the international safety regulations such as IEC/UL 62368-1. LRS-200N2 series serves as a high price-to-performance power supply solution for various industrial applications. Moreover, LRS-200N2 can provide 200% short-duration peak power for motor applications and electromechanical loads requiring much higher power during start-up.

■ Model Encoding

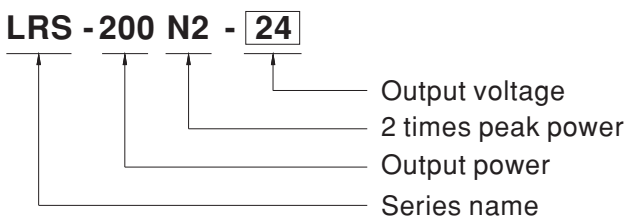

File Name:LRS-200N2-SPEC 2023-07-14

SPECIFICATION

MODEL	LRS-200N2-12	LRS-200N2-24	LRS-200N2-36	LRS-200N2-48	
OUTPUT	DC VOLTAGE	12V	24V	36V	48V
	RATED CURRENT	17A	8.8A	5.9A	4.4A
	CURRENT RANGE	0 ~ 17A	0 ~ 8.8A	0 ~ 5.9A	0 ~ 4.4A
	RATED POWER	204W	211.2W	212.4W	211.2W
	RIPPLE & NOISE (max.) Note.2	150mVp-p	150mVp-p	200mVp-p	200mVp-p
	VOLTAGE ADJ. RANGE	10.2 ~ 13.8V	21.6 ~ 28.8V	32.4 ~ 39.6V	43.2 ~ 52.8V
	VOLTAGE TOLERANCE Note.3	±1.5%	±1.0%	±1.0%	±1.0%
	LINE REGULATION Note.4	±0.5%	±0.5%	±0.5%	±0.5%
	LOAD REGULATION Note.5	±1.0%	±0.5%	±0.5%	±0.5%
	SETUP, RISE TIME	1300ms, 50ms/230VAC 1300ms,50ms/115VAC at full load			
HOLD UP TIME (Typ.)	16ms/230VAC 12ms/115VAC at full load				
INPUT	VOLTAGE RANGE	90 ~ 132VAC / 180 ~ 264VAC by switch 240 ~ 370VDC (switch on 230VAC)			
	FREQUENCY RANGE	47 ~ 63Hz			
	EFFICIENCY (Typ.)	87.5%	89.5%	89.5%	90%
	AC CURRENT (Typ.)	4A/115VAC 2.2A/230VAC			
	INRUSH CURRENT (Typ.)	COLD STAR 60A/115VAC 60A/230VAC			
	LEAKAGE CURRENT	<2mA / 240VAC			
PROTECTION	OVER LOAD	Output power >105% rated for more than 5 seconds then shut down o/p voltage, re-power on to recover Output power >200% rated, hiccup mode, recovers automatically after fault condition is removed			
	OVER VOLTAGE	13.8 ~ 16.2V	28.8 ~ 33.6V	41.4 ~ 46.8V	55.2 ~ 64.8V
		Shut down and latch off o/p voltage, re-power on to recover.			
	OVER TEMPERATURE	Shut down and latch off o/p voltage, re-power on to recover.			
ENVIRONMENT	WORKING TEMP.	-25 ~ +70°C (Refer to "Derating Curve")			
	WORKING HUMIDITY	20 ~ 90% RH non-condensing			
	STORAGE TEMP., HUMIDITY	-40 ~ +85°C, 10 ~ 95% RH			
	TEMP. COEFFICIENT	±0.03%/°C (0 ~ 50°C)			
	VIBRATION	10 ~ 500Hz, 5G 10min./1cycle, 60min. each along X, Y, Z axes			
	OVER VOLTAGE CATEGORY	III: According to EN61558, EN50178, EN60664-1, EN62477-1; altitude up to 2000 meters			
SAFETY	SAFETY STANDARDS	IEC/UL 62368-1, BSMI CNS14336-1,EAC TP TC 004,BIS IS13252(Part1): 2010/IEC 60950-1: 2005; BS EN/EN61558-1, BS EN61558-2-16 Designed by BS/EN/EN62368-1, AS/NZS 61558.1/2.16, AS/NZS 62368.1			
	WITHSTAND VOLTAGE	I/P-O/P:3.75KVAC I/P-FG:2KVAC O/P-FG:0.5KVAC			
	ISOLATION RESISTANCE	I/P-O/P, I/P-FG, O/P-FG:100M Ohms / 500VDC / 25°C / 70% RH			
	EMC EMISSION	Compliance to BSMI CNS13438, EAC TP TC 020			
	EMC IMMUNITY	Compliance to BS EN/EN55035, EAC TP TC 020			
OTHERS	MTBF	2089.1K hrs min. Telcordia SR-332 (Bellcore) ; 243.6Khrs min. MIL-HDBK-217F (25°C)			
	DIMENSION	215*115*30mm (L*W*H)			
	PACKING	0.66Kg; 15pcs/10.9Kg/0.78CUFT			
NOTE	<p>1. All parameters NOT specially mentioned are measured at 230VAC input, rated load and 25°C of ambient temperature.</p> <p>2. Ripple & noise are measured at 20MHz of bandwidth by using a 12" twisted pair-wire terminated with a 0.1uf & 47uf parallel capacitor.</p> <p>3. Length of set up time is measured at cold first start. Turning ON/OFF the power supply very quickly may lead to increase of the set up time.</p> <p>4. This power supply does not meet the harmonic current requirements outlined by BS EN/EN61000-3-2. Please do not use this power supply under the following conditions:</p> <ul style="list-style-type: none"> a) the end-devices is used within the European Union, and b) the end-devices is connected to public mains supply with 220Vac or greater rated nominal voltage, and c) the power supply is: <ul style="list-style-type: none"> - installed in end-devices with average or continuous input power greater than 75W, or - belong to part of a lighting system <p>Exception: Power supplies used within the following end-devices do not need to fulfill BS EN/EN61000-3-2</p> <ul style="list-style-type: none"> a) professional equipment with a total rated input power greater than 1000W; b) symmetrically controlled heating elements with a rated power less than or equal to 200W <p>5. RCM is on voluntary basis and meets relevant IEC or AS/NZS standards complying with AS/NZS 4417.1.</p> <p>※ Product Liability Disclaimer : For detailed information, please refer to https://www.meanwell.com/serviceDisclaimer.aspx</p>				

■ **Block Diagram**

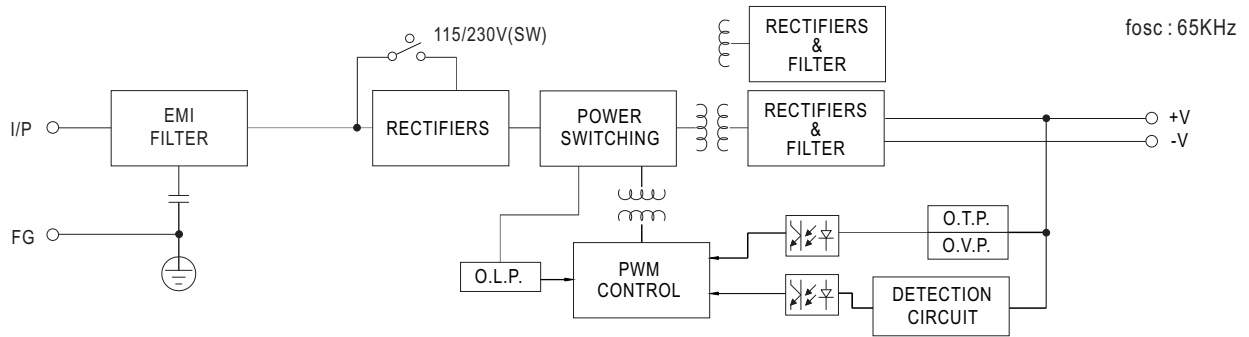

■ **Derating Curve**

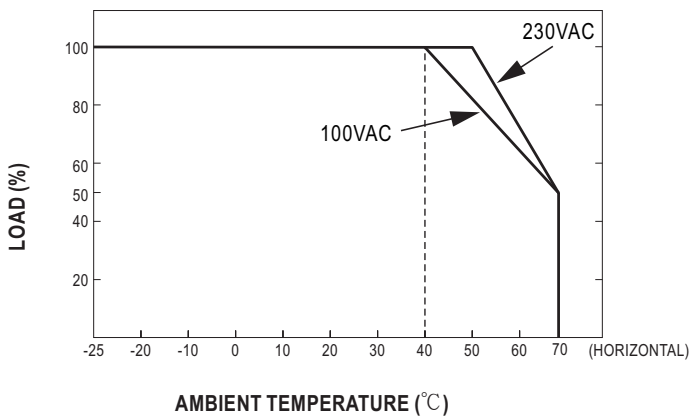

■ **Static Characteristics**

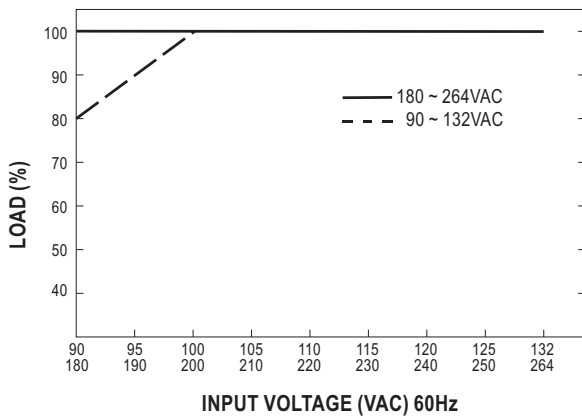

■ Function Manual

1. Peak Power

$$P_{av} = \frac{P_{pk} \times t + P_{npk} \times (T-t)}{T} \leq P_{rated}$$

$$Duty = \frac{t}{T} \times 100\% \leq 35\%$$

$$t \leq 5 \text{ sec}$$

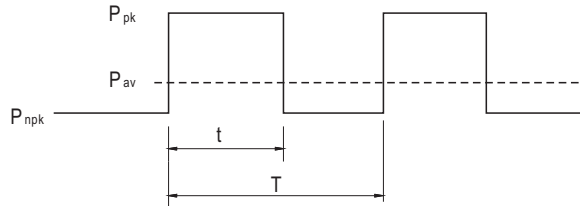

P_{av} : Average output power (W)

P_{pk} : Peak output power (W)

P_{nkp} : Non-peak output power (W)

P_{rated} : Rated output power (W)

t : Peak power width (sec)

T : Period (sec)

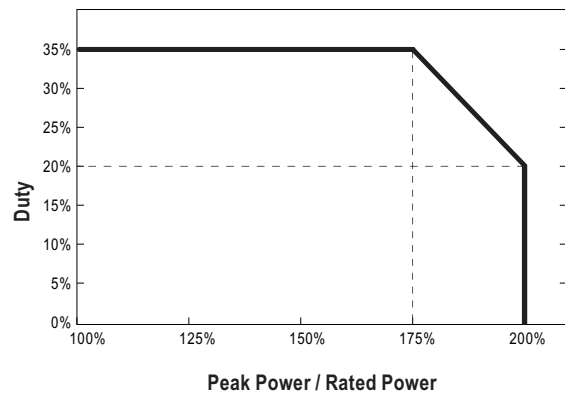
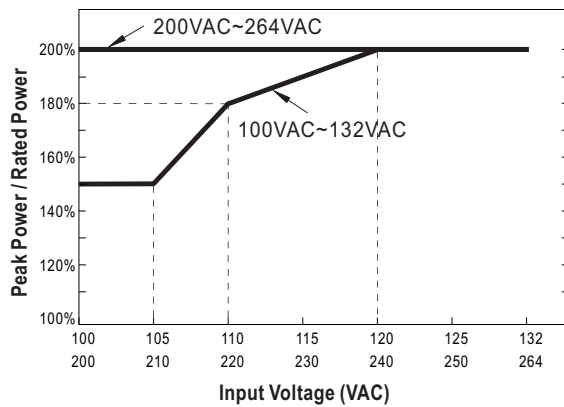

For example (24 model)

$V_{in}=220VAC$, $Duty_max=10\%$

$P_{av}=P_{rated}=200W$

$P_{pk}=400W$

$t \leq 5 \text{ sec}$

$$T \geq \frac{5 \text{ sec}}{10\%} = 50 \text{ sec}$$

$$P_{nkp} \leq \frac{TP_{av} - tP_{pk}}{T-t} = 178W$$

Mechanical Specification

Case No. 207 Unit:mm

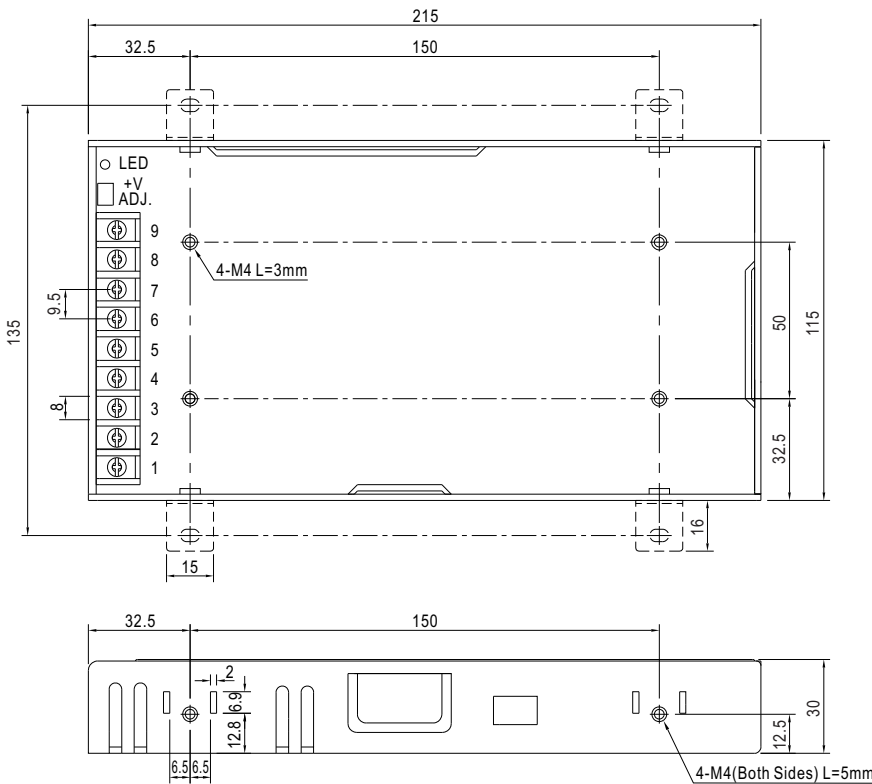

Terminal Pin No. Assignment :

Pin No.	Assignment	Pin No.	Assignment
1	AC/L	4~6	DC OUTPUT -V
2	AC/N	7~9	DC OUTPUT +V
3	FG \perp		