

■ Features

- MEAN WELL Patent Number: ZL 202223277512.1
- 5"×3" compact size with **low profile** (12V: 35mm ,15~54V: 33.5mm)
- 80~264Vac input with PFC, No load power consumption<0.5W
- **Global certificates in multi-fields** (ITE 62368-1, Medical 60601-1, Household 60335-1, Industrial 61558-1/-2-16)
- **150%peak** load @ 3s
- **400W** convection, **600W** with FAN **23CFM** forced-cooled
- Suitable for **Class I** or **Class II** installations
- Over voltage category **III (OVC III)**
- **-40 ~ +80°C** wide range operation temperature
- High efficiency up to 95%
- Protections: Short circuit / Overload / Over voltage / Over temperature
- Extremely low leakage current
- Operating altitude up to **5000 meters**
- Built-in 12V/0.5A for external FAN
- 3 years warranty

■ Applications

- Industrial automation machinery
- Industrial control system
- Mechanical and electrical equipment
- Electronic instruments, equipments or apparatus
- Power sourcing equipment of PoE
- Medical devices

■ Description

LOP-600 is a 600W highly reliable green PCB type low profile power supply with a high power density (30.3W/in³) on the 5" by 3" footprint. It accepts 80~264VAC input and offers various output voltages between 12V and 54V. The working efficiency is up to 95% and the extremely low no load power consumption is down below 0.5W.

LOP-600 is able to be used for both Class I (with FG) and Class II (no FG) system design. LOP-600 is equipped with complete protection functions; It is complied with the international safety regulations such as IEC/BS EN/EN/UL62368-1, IEC/BS EN/EN60335-1, IEC/BS EN/EN61558-1/-2-16, IEC/BS EN/EN60601-1. LOP-600 serves as a high price-to-performance power supply solution for various industrial applications. The extremely low leakage current is less than 500 μA. In addition, it conforms to the international medical regulations (2*MOPP) and EMC BS EN/EN55011, perfectly fitting all kinds of BF rated "patient contact" medical system equipment.

■ Model Encoding

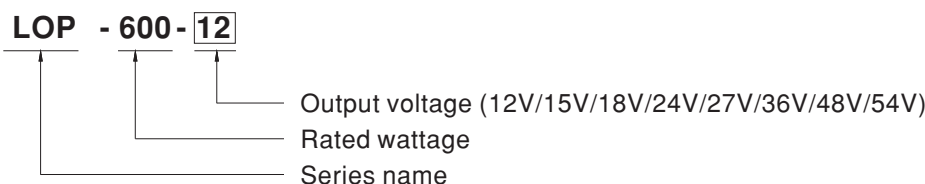

File Name:LOP-600-SPEC 2023-11-22

SPECIFICATION

MODEL		LOP-600-12	LOP-600-15	LOP-600-18	LOP-600-24	LOP-600-27	LOP-600-36	LOP-600-48	LOP-600-54	
OUTPUT	DC VOLTAGE	12V	15V	18V	24V	27V	36V	48V	54V	
	CURRENT	Peak(3sec.)	75A	60A	50A	37.5A	33.3A	25A	18.8A	16.7A
		23CFM	50A	40A	33.3A	25A	22.3A	16.7A	12.5A	11.2A
		Convection	30A	24A	20A	16.7A	14.8A	11.1A	8.3A	7.4A
	RATED POWER	Peak(3sec.)	900W	900W	900W	900W	899.1W	900W	902.4W	901.8W
		23CFM	600W	600W	599.4W	600W	602.1W	601.2W	600W	604.8W
		Convection	360W	360W	360W	400.8W	399.6W	399.6W	398.4W	399.6W
	RIPPLE & NOISE (max.) Note.2	120mVp-p	150mVp-p	180mVp-p	200mVp-p	200mVp-p	250mVp-p	250mVp-p	250mVp-p	250mVp-p
	VOLTAGE ADJ. RANGE(MAIN OUTPUT)	11.4~12.6V	14.3~15.8V	17.1~18.9V	22.8~25.2V	25.6 ~ 28.4V	34.2 ~37.8V	45.6 ~50.4V	52 ~58V	
	VOLTAGE TOLERANCE Note.3	±3.0%	±3.0%	±3.0%	±2.0%	±1.0%	±1.0%	±1.0%	±1.0%	±1.0%
LINE REGULATION	±0.5%	±0.5%	±0.5%	±0.5%	±0.5%	±0.5%	±0.5%	±0.5%	±0.5%	
LOAD REGULATION	±1.0%	±1.0%	±1.0%	±1.0%	±1.0%	±1.0%	±1.0%	±1.0%	±1.0%	
SETUP, RISE TIME	1000ms, 50ms/230VAC 1500ms, 50ms/115VAC at full load									
HOLD UP TIME (Typ.)	12ms@400W load , 8ms@600W load									
INPUT	VOLTAGE RANGE Note.4	80 ~ 264VAC		113 ~ 370VDC						
	FREQUENCY RANGE	47 ~ 63Hz								
	POWER FACTOR	PF>0.95/230VAC PF>0.98/115VAC at full load								
	EFFICIENCY (Typ.)	93%	93.5%	94%	94%	95%	95%	95%	95%	95%
	AC CURRENT (Typ.)	6.4A/115VAC		3.2A/230VAC						
	INRUSH CURRENT (Typ.)	COLD START 40A/115VAC			80A/230VAC					
	LEAKAGE CURRENT	Earth leakage current < 500 μ A(rms) @ 264VAC , touch current < 70 μ A(rms) @ 264VAC								
PROTECTION	OVERLOAD	105 ~ 150% rated output power, Protection type : Hiccup after 3 sec, recovers automatically after fault condition is removed								
	OVER VOLTAGE	13.2 ~ 15.6V	16.5 ~ 19.5V	19.8 ~ 23.4V	26.4 ~ 31.2V	29.7 ~ 35.1V	39.6 ~ 46.8V	52.8 ~ 62.4V	59.4 ~ 67.5V	
		Protection type : Shut down o/p voltage, re-power on to recover								
OVER TEMPERATURE	Protection type : Shut down o/p voltage, recovers automatically after temperature goes down (Vin=115Vac) Shut down o/p voltage, re-power on to recover (Vin=230Vac on Fan Lock)									
FUNCTION	EXTERNAL FAN SUPPLY	12V@0.5A for driving a fan / 12V@0.2A for without fan; (23CFM) tolerance -15% ~+15% at main output 20% rated current								
	REMOTE SENSE	The remote sensing compensates voltage drop on the load wiring up to 0.5V								
	POWER GOOD / POWER FAIL (optional)	500ms>PG>10ms ; The TTL signal goes high with 10ms to 500ms delay after power set up ; The TTL signal goes low at least 1ms before Vo below 90% of rated value; TTL(0 ~ 1V), TTH(2 ~ 5V)								
ENVIRONMENT	WORKING TEMP.	-40 ~ +80°C (Refer to "Derating Curve")								
	WORKING HUMIDITY	20 ~ 90% RH non-condensing								
	STORAGE TEMP., HUMIDITY	-40 ~ +85°C, 10 ~ 95% RH non-condensing								
	TEMP. COEFFICIENT	±0.03%/°C (0 ~ 50°C)								
	VIBRATION	10 ~ 500Hz, 2G 10min./1cycle, 60min. each along X, Y, Z axes								

SAFETY & EMC (Note 5)	SAFETY STANDARDS	CB IEC62368-1, IEC60335-1, IEC61558-1/-2-16, IEC60601-1; TUV BS EN/EN62368-1, BS EN/EN60335-1, BS EN/EN61558-1/-2-16, BS EN/EN60601-1(3.2 Version); UL UL62368-1, ANSI / AAMI ES60601-1(3.2 Version) ; CCC GB4943.1 ; RCM AS/NZS 61558-1/-2-16; EAC TPTC 004 approved.		
	OVER VOLTAGE CATEGORY	IEC/EN 61558-1/-2-16(OVC III, altitude up to 2000M) IEC/EN/UL 62368-1 (OVC II, altitude up to 5000M) IEC/EN 60335-1 (OVC II, altitude up to 5000M) IEC/EN 60601-1 (OVC II, altitude up to 4000M)		
	PROTECTIVE EXTRA-LOW VOLTAGE	IEC/EN61558-2-16 (SELV) IEC/EN/UL 62368-1 (SELV / ES1)		
	WITHSTAND VOLTAGE	I/P-O/P:4KVAC I/P-FG:2KVAC O/P-FG:1.5KVAC		
	ISOLATION RESISTANCE	I/P-O/P, I/P-FG, O/P-FG:100M Ohms / 500VDC / 25°C/ 70% RH		
	EMC EMISSION	Parameter	Standard	Test Level / Note
		Conducted & Radiated	BS EN/EN55032(CISPR32)	Class I : Class B , Class II : Class A
			BS EN/EN55014(CISPR32)	Class I : Class B
		Harmonic Current	BS EN/EN61000-3-2	Class A
	Voltage Flicker	BS EN/EN61000-3-3	-----	
EMC IMMUNITY	BS EN/EN55035,BS EN/EN61000-6-2			
	Parameter	Standard	Test Level /Note	
	ESD	BS EN/EN61000-4-2	Level 4, 15KV air ; Level 4, 8KV contact	
	Radiated Susceptibility	BS EN/EN61000-4-3	Level 3, 10V/m(80MHz~2.7GHz) Table 9, 9~28V/m(385MHz~5.78GHz)	
	EFT/Burest	BS EN/EN61000-4-4	Level 3, 2KV	
	Surge	BS EN/EN61000-4-5	Level 4, 4KV/Line-FG ; 2KV/Line-Line	
	Conducted	BS EN/EN61000-4-6	Level 3, 10V	
	Magnetic Field	BS EN/EN61000-4-8	Level 4, 30A/m	
Voltage Dips and interruptions	BS EN/EN61000-4-11	>95% dip 0. 5 periods, 100% dip 1 periods, 30% dip 25 periods, >95% interruptions 250 periods		
OTHERS	MTBF	1963.2K hrs min. Telcordia SR-332 (Bellcore) ; 310.9K hrs min. MIL-HDBK-217F (25°C)		
	DIMENSION	12V: 127*76.2*35mm (L*W*H) , 15~54V: 127*76.2*33.5mm (L*W*H)		
	PACKING	0.48Kg; 24pcs/13.7Kg/1.10CUFT		
NOTE	<p>1. All parameters NOT specially mentioned are measured at 230VAC input, rated load and 25 of ambient temperature.</p> <p>2. Ripple & noise are measured at 20MHz of bandwidth by using a 12" twisted pair-wire terminated with a 0.1μf & 47μf parallel capacitor.</p> <p>3. Tolerance : includes set up tolerance, line regulation and load regulation.</p> <p>4. Derating may be needed under low input voltages. Please check the derating curve for more details.</p> <p>5. The power supply is considered a component which will be installed into a final equipment. All the EMC tests are been executed by mounting the unit on a 360mm*360mm metal plate with 1mm of thickness. The final equipment must be re-confirmed that it still meets EMC directives. For guidance on how to perform these EMC tests, please refer to "EMI testing of component power supplies." (as available on http://www.meanwell.com)</p> <p>※ Product Liability Disclaimer : For detailed information, please refer to https://www.meanwell.com/serviceDisclaimer.aspx</p>			

Block Diagram

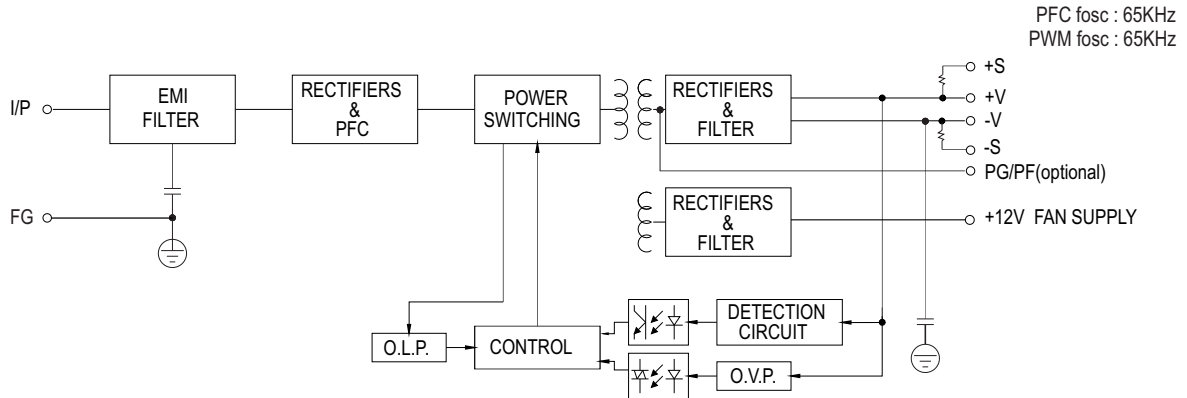

Derating Curve

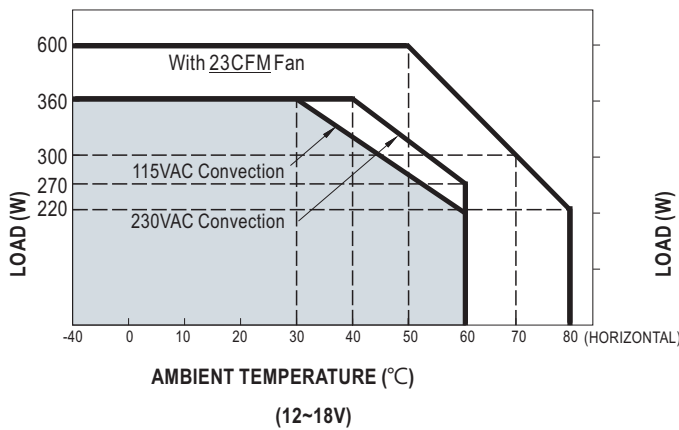

Cooling	Max. Output Power
Free air convection	360W
Force air with external Fan	600W

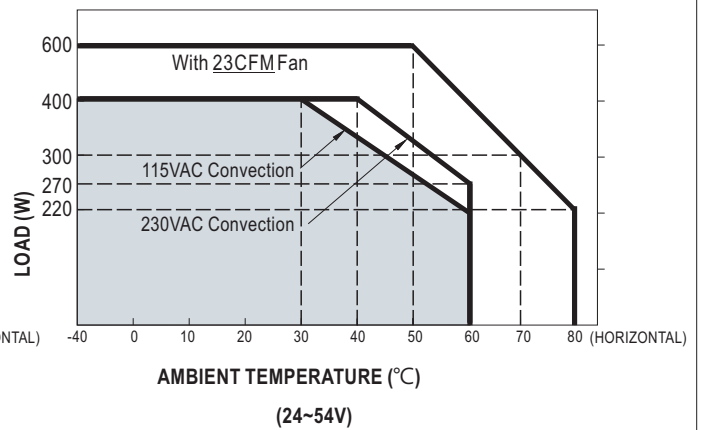

Cooling	Max. Output Power
Free air convection	400W
Force air with external Fan	600W

Output Derating VS Input Voltage

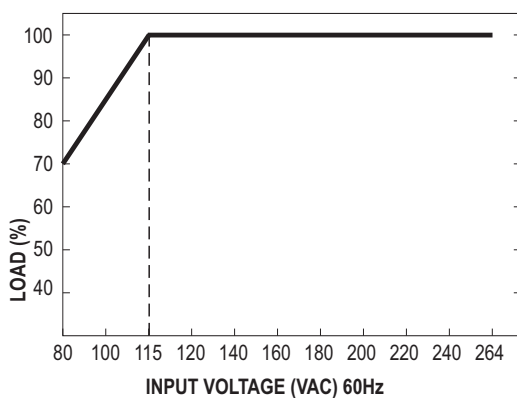

■ Mechanical Specification

Unit:mm

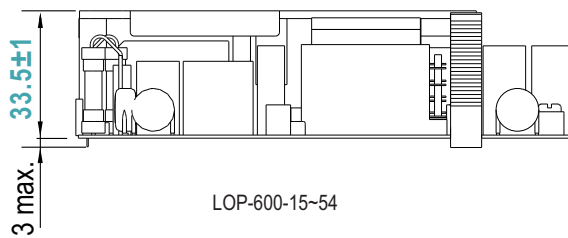
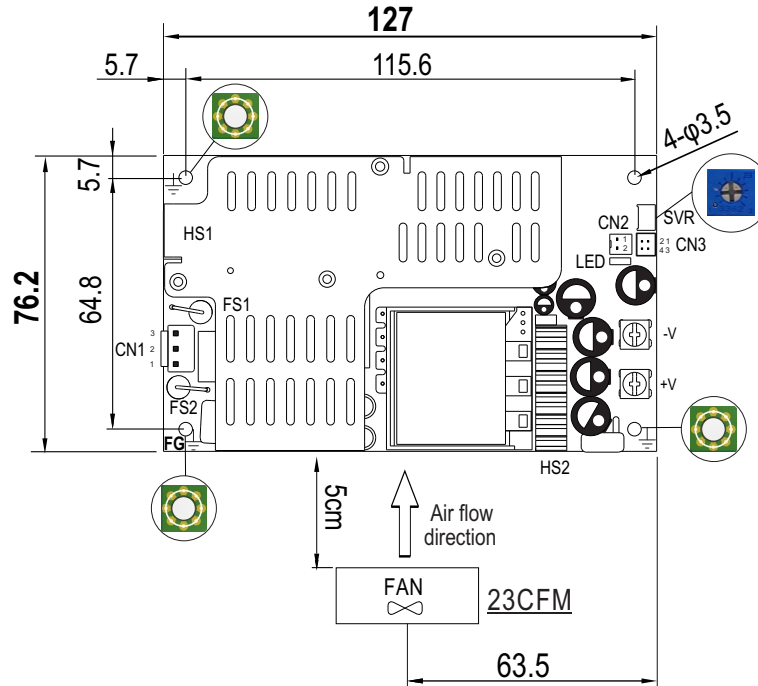

LOP-600-15~54

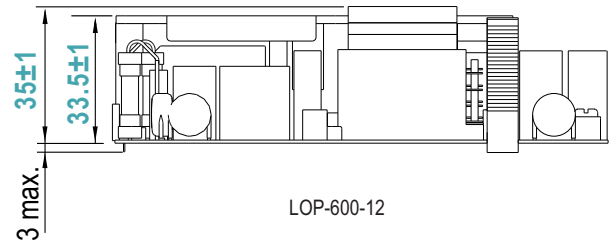

LOP-600-12

AC Input Connector (CN1) : JST B3P-VH or equivalent

Pin No.	Assignment	Mating Housing	Terminal
1	AC/L	JST VHR or equivalent	JST SVH-21T-P1.1 or equivalent
2	No Pin		
3	AC/N		

DC Output Connector

Assignment	Output Terminals
-V	M3.5 Pan HD screw in 2 positions
+V	Torque to 8 lbs-in(90cNm)max.

Function Connector(CN3): TKP DH21-2X2 or equivalent

Pin No.	Assignment	Mating Housing	Terminal
1	-S	TKP DH2 or equivalent	TKP or equivalent
2	+S		
3	DC COM		
4	PG(optional)		

FAN Connector(CN2) : TKP 8812-2 or equivalent

Pin No.	Assignment	Mating Housing	Terminal
1	DC COM	TKP 2502 or equivalent	TKP 8811 or equivalent
2	+12V		

Note:

Class I System: Mounting holes marked with \perp have to be connected to safety earth.

Class II System: Unnecessary to connect with safety earth.

⚠ HS1,HS2 can not be shorted