



■ Features

- Constant Current mode output with multiple levels selectable by dip switch
- KNX/EIB protocol
- Flicker free design
- Support emergency lighting(EL)
- Integrated constant light output
- Integrated KNX push button interface
- Synchronization up to 10units
- Functions: Manual dim, operation hours, power consumption feedback, log/linear curve selection...etc
- 3 years warranty

■ Applications

- LED indoor lighting
- LED office lighting
- LED architectural lighting
- LED panel lighting

■ Description

LCM-60KN series is a 60W AC/DC constant current mode output LED driver featuring the multiple levels selectable by dip switch and the KNX interface to avoid using the complicated KNX-DALI gateway. LCM-60KN operates from 180~ 295VAC and offers different current levels ranging between 500mA and 1400mA. Thanks to the high efficiency up to 91%, with the fanless design, the entire series is able to operate for -30°C ~+90°C case temperature under free air convection. In addition, LCM-60KN is equipped with push dimming and synchronization so as to provide the optimal design flexibility for LED lighting system.

■ Model Encoding

LCM - 60KN - **AUX**

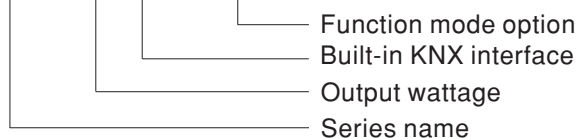

Type	Function	Note
Blank	KNX and push dimming ,with standby power consumption <0.5W	In Stock
AUX	KNX and push dimming, with standby power consumption <1.2W and Auxiliary DC output	By request

File Name:LCM-60KN-SPEC 2019-07-31

SPECIFICATION

MODEL		LCM-60KN-□					
OUTPUT	CURRENT LEVEL	Current level selectable via DIP switch, please refer to "DIP SWITCH TABLE" section					
		500mA	600mA	700mA(default)	900mA	1050mA	1400mA
	RATED POWER	60.3W					
	DC VOLTAGE RANGE	2 ~ 90V	2 ~ 90V	2 ~ 86V	2 ~ 67V	2 ~ 57V	2 ~ 42V
	OPEN CIRCUIT VOLTAGE (max.)	95V			73V		
	CURRENT RIPPLE Note.5	5.0% max. @rated current					
	CURRENT TOLERANCE	±5%					
	AUXILIARY DC OUTPUT	Nominal 12V(deviation 11.4~12.6V)@50mA for AUX-Type only					
SETUP TIME Note.3	500ms / 230VAC						
INPUT	VOLTAGE RANGE Note.2	180 ~ 295VAC 220 ~ 417VDC (Please refer to "STATIC CHARACTERISTIC" section)					
	FREQUENCY RANGE	47 ~ 63Hz					
	POWER FACTOR (Typ.)	PF ≥ 0.975/230VAC, PF ≥ 0.93/277VAC@full load (Please refer to "POWER FACTOR (PF) CHARACTERISTIC" section)					
	TOTAL HARMONIC DISTORTION	THD < 20%(@load ≥ 75%) (Please refer to "TOTAL HARMONIC DISTORTION(THD)" section)					
	EFFICIENCY (Typ.) Note.4	91%					
	AC CURRENT (Typ.)	0.32A/230VAC					
	INRUSH CURRENT (Typ.)	COLD START 20A(twidth=320µs measured at 50% I _{peak}) at 230VAC; Per NEMA 410					
	MAX. No. of PSUs on 16A CIRCUIT BREAKER	20 units (circuit breaker of type B) / 34 units (circuit breaker of type C) at 230VAC					
	LEAKAGE CURRENT	<0.5mA / 240VAC					
	STANDBY POWER CONSUMPTION Note.6	<0.5W for Blank-Type, <1.2W for AUX-Type					
PROTECTION	SHORT CIRCUIT	Constant current limiting, recovers automatically after fault condition is removed					
	OVER VOLTAGE	105 ~ 125V Shutdown o/p voltage, re-power on to recover					
	OVER TEMPERATURE	Shutdown o/p voltage, re-power on to recover					
FUNCTION	DIMMING	Please refer to "DIMMING OPERATION" section					
	SYNCHRONIZATION	Please refer to "SYNCHRONIZATION OPERATION" section					
	TEMP. COMPENSATION	By external NTC, please refer to "TEMPERATURE COMPENSATION OPERATION" section					
ENVIRONMENT	WORKING TEMP.	T _{case} =-30 ~ +90°C (Please refer to "OUTPUT LOAD vs TEMPERATURE" section)					
	MAX. CASE TEMP.	T _{case} =+90°C					
	WORKING HUMIDITY	20 ~ 90% RH non-condensing					
	STORAGE TEMP., HUMIDITY	-40 ~ +80°C, 10 ~ 95% RH					
	TEMP. COEFFICIENT	±0.03%/°C (0 ~ 50°C)					
	VIBRATION	10 ~ 500Hz, 2G 10min./1cycle, period for 60min. each along X, Y, Z axes					
SAFETY & EMC	SAFETY STANDARDS	ENEC EN61347-1, EN61347-2-13, EN62384 independent, EAC TP TC 004 approved, GB19510.14 and GB19510.1(by request)					
	KNX STANDARDS	Certified protocol					
	WITHSTAND VOLTAGE	I/P-O/P:3.75KVAC					
	ISOLATION RESISTANCE	I/P-O/P:>100M Ohms / 500VDC / 25°C / 70% RH					
	EMC EMISSION Note.7	Compliance to EN55015, EN61000-3-2 Class C(@load ≥ 40%) ; EN61000-3-3; GB17625.1,GB17743, EAC TP TC 020					
	EMC IMMUNITY	Compliance to EN61000-4-2,3,4,5,6,8,11, EN61547, light industry level(surge immunity Line-Line 2KV), EAC TP TC 020					
OTHERS	MTBF	193.6K hrs min. MIL-HDBK-217F (25°C)					
	DIMENSION	123.5*81.5*23mm (L*W*H)					
	PACKING	0.24Kg ; 54pcs/15Kg/1.12CUFT					
NOTE	<ol style="list-style-type: none"> All parameters NOT specially mentioned are measured at 230VAC input, rated current and 25°C of ambient temperature. De-rating may be needed under low input voltages. Please refer to "STATIC CHARACTERISTIC" sections for details. Length of set up time is measured at first cold start. Turning ON/OFF the driver may lead to increase of the set up time. Efficiency is measured at 900mA/67V output set by DIP switch. Current ripple is measured 60%~100% of maximum voltage under rated power delivery. Standby power consumption is measured at 180~230VAC. The driver is considered as a component that will be operated in combination with final equipment. Since EMC performance will be affected by the complete installation, the final equipment manufacturers must re-qualify EMC Directive on the complete installation again. The ambient temperature derating of 3.5°C/1000m with fanless models and of 5°C/1000m with fan models for operating altitude higher than 2000m(6500ft). 						

■ BLOCK DIAGRAM

PFC fosc : 60KHz
PWM fosc : 80KHz

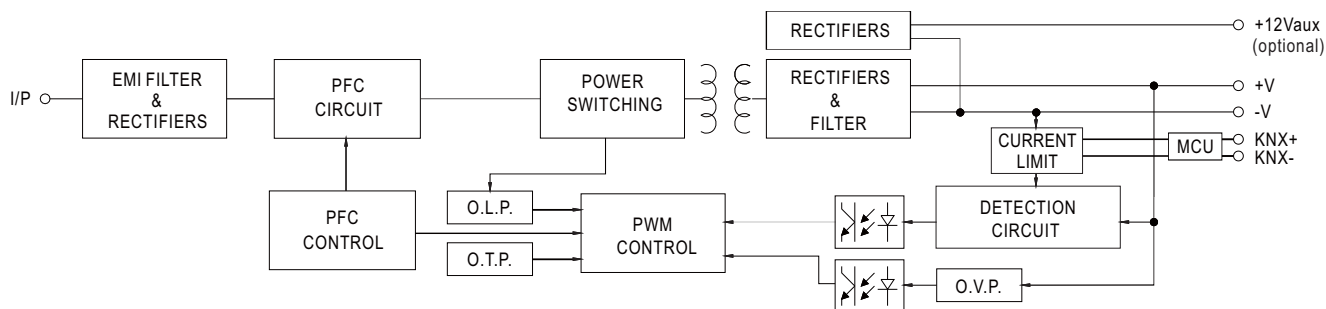

■ DIP SWITCH TABLE

LCM-60KN is a multiple-stage constant current driver, selection of output current through DIP switch is exhibited below.

Io \ DIP S.W.	1	2	3	4	5	6
500mA	----	----	----	----	----	----
600mA	ON	----	----	----	----	----
700mA(factory default)	ON	ON	----	----	----	----
900mA	ON	ON	ON	----	----	ON
1050mA	ON	ON	ON	ON	----	ON
1400mA	ON	ON	ON	ON	ON	ON

■ DIMMING OPERATION

※ KNX interface

- Apply KNX Bus cable between KNX+ and KNX-
- The application program(database) can be downloaded via Online Catalogs from ETS or via <http://www.meanwell.com/productCatalog.aspx>

Parametrization options	Description
Switch functions	<ul style="list-style-type: none"> • Turn on brightness • Dimming speed for turn on/off • Switch telegram and status • Switch on/off delay
Dimming	<ul style="list-style-type: none"> • Dimming speed for 0~100% • Allow switch on via relative dimming • Push dimming with AC input port • Block object for push dimming
Brightness value	<ul style="list-style-type: none"> • Dimming speed for transition brightness values • Permit set switch on and off brightness via value • Brightness value and status
Fault message	<ul style="list-style-type: none"> • Lamp fault • AC/DC input monitor fault messages
Other functions	<ul style="list-style-type: none"> • Reaction on KNX voltage failure/recovery • Power-On level • Dimming curve select(linear/log) • Synchronous dimming output • Block function(Block1&Block2) • Staircase lighting function(multi-stage switch-off)
General function	<ul style="list-style-type: none"> • Cyclic monitoring telegram(In operation)
8 Scenes	<ul style="list-style-type: none"> • Recall and save via KNX with 8-bit telegram
Operating hours & CLO	<ul style="list-style-type: none"> • Operating hours counter • Constant light out(5 scheduled divisions)
Power consumption feedback	<ul style="list-style-type: none"> • Power consumption report

※ CONSTANT LIGHT OUTPUT

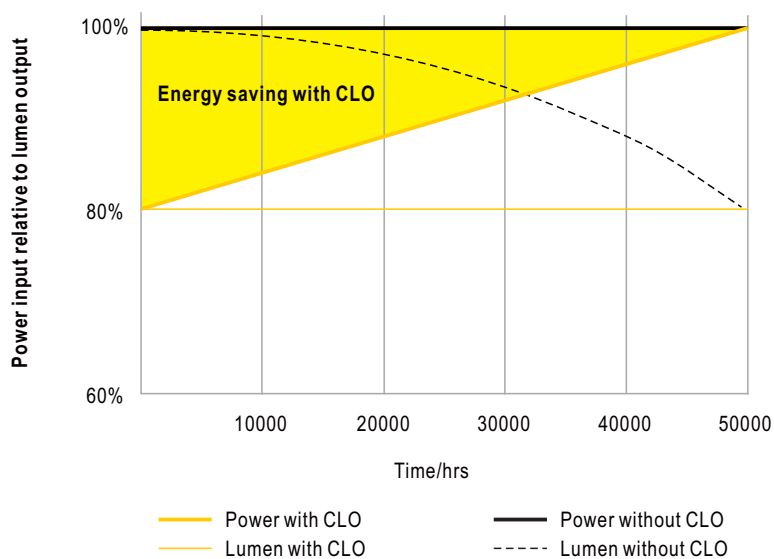

※ **PUSH dimming or AC/DC input monitor (Primary side)**

◎ **PUSH dimming**

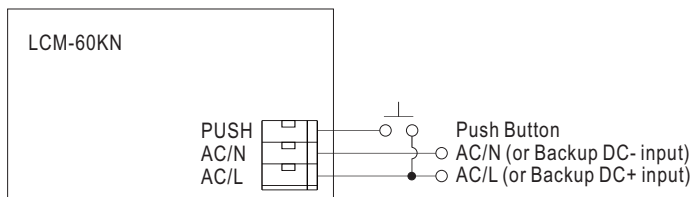

- KNX bus need to be connected when using PUSH Dimming
- The detailed function of PUSH dimming, please refer to the database.
- The maximum length of the cable between the push button and driver is 20 meters.
- The mechanical push button can be connected only between the PUSH terminal, as displayed in the diagram, and AC/L (in brown or black); it will lead to short circuit if it is connected to AC/N.
- In case the PUSH dimming is set locally, up to 10 drivers can perform the PUSH dimming at the same time when utilizing one common push button.
- In case the PUSH dimming is set independently via ETS, the number of drivers is done through group address and determined by the ETS project designer.

◎ **AC/DC input monitor**

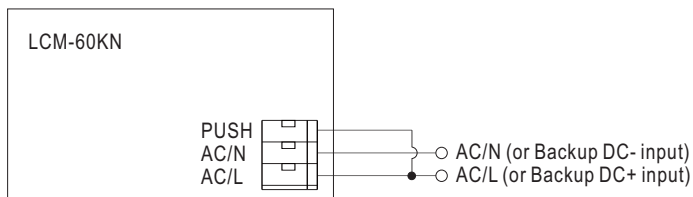

- KNX bus need to be connected when using AC/DC input monitor
- The detailed function of AC/DC input monitor(emergency lighting), please refer to the database and instruction manual.

■ **SYNCHRONIZATION OPERATION**

- Synchronization up to 10 drivers (1 master + 9 slaves)
- Dimming operating range : 6%~100%
- Sync cable length : < 5m
- Sync cable type : Flat cable
- Sync cable cross section area : 22 – 24 AWG (0.2~0.3mm²)

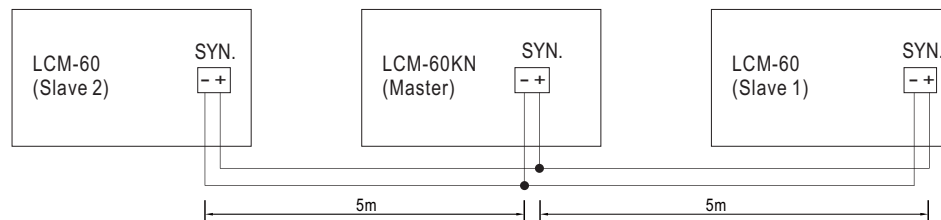

NOTE : Min. Dimming operating range depends on database setting.

■ TEMPERATURE COMPENSATION OPERATION

LCM-60KN have the built-in temperature compensation function ; by connecting a temperature sensor (NTC resistor) between the +NTC / -NTC terminal of LCM-60KN and the detecting point on the lighting system or the surrounding environment, output current of LCM-60KN could be correspondingly changed, based on the sensed temperature, to ensure the long life of LED.

NTC derating curve

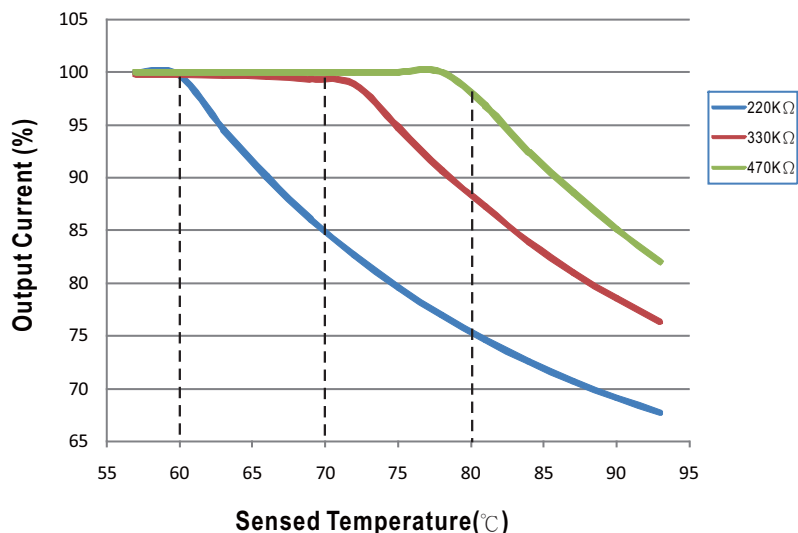

- ⊙ LCM-60KN can still be operated normally when the NTC resistor is not connected and the value of output current will be the current level selected through the DIP switch.
- ⊙ NTC reference:

NTC resistance	Output Current
220K	< 60°C, 100% of the rated current (corresponds to the setting current level) > 60°C, output current begins to reduce, please refer to the curve for details.
330K	< 70°C, 100% of the rated current (corresponds to the setting current level) > 70°C, output current begins to reduce, please refer to the curve for details.
470K	< 80°C, 100% of the rated current (corresponds to the setting current level) > 80°C, output current begins to reduce, please refer to the curve for details.

Notes: 1. MEAN WELL does not offer the NTC resistor and all the data above are measured by using THINKING TTC03 series.
2. If other brands of NTC resistor is applied, please check the temperature curve first.

- ⊙ KNX control, dimming and synchronization function of the driver will be invalid when the "temperature compensation" function is in use.

OUTPUT LOAD vs TEMPERATURE

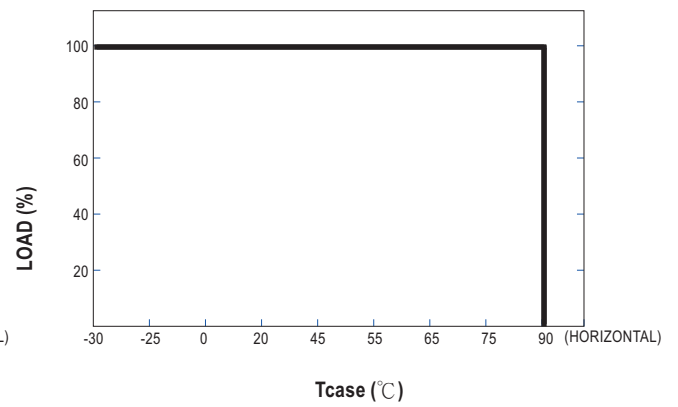
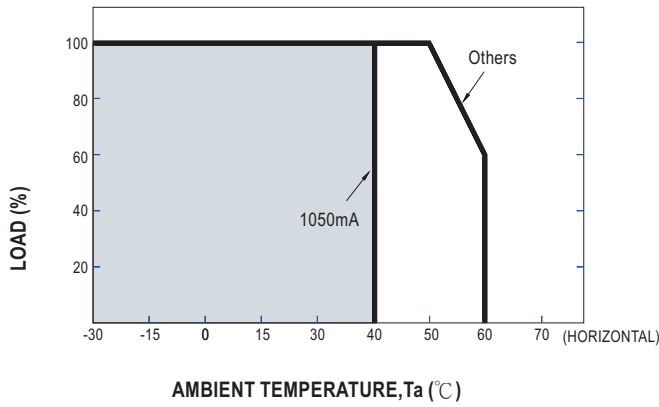

STATIC CHARACTERISTIC

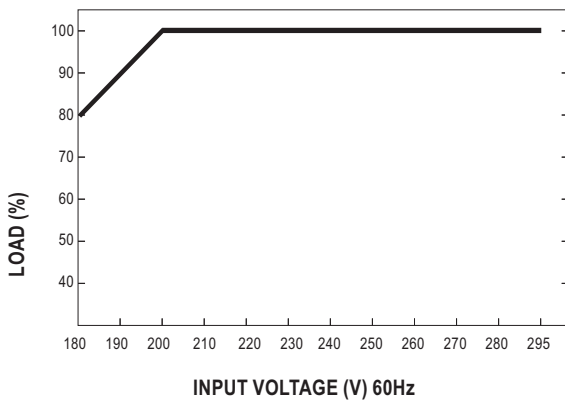

※ De-rating is needed under low input voltage.

TOTAL HARMONIC DISTORTION (THD)

※ Tcase at 80°C

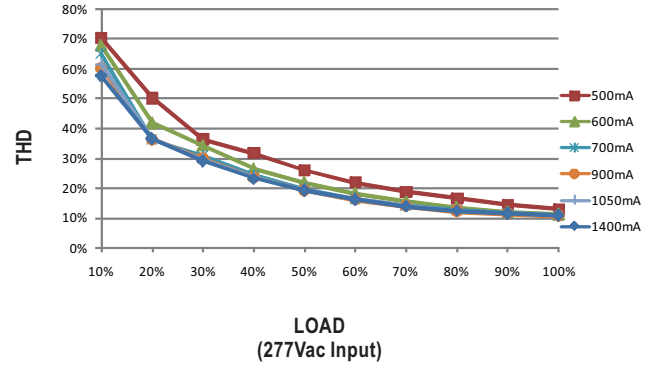
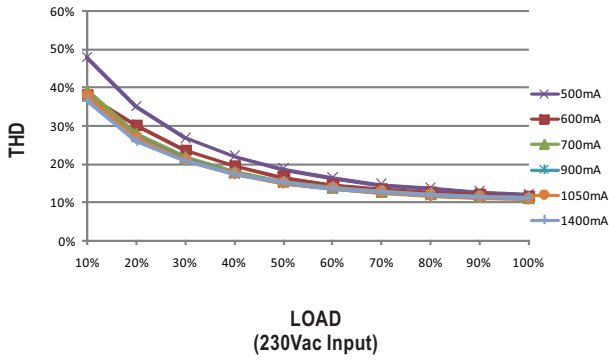

POWER FACTOR (PF) CHARACTERISTIC

※ Tcase at 80°C

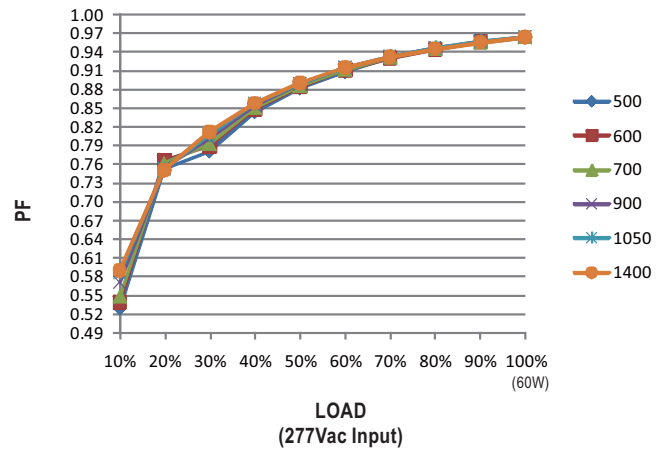
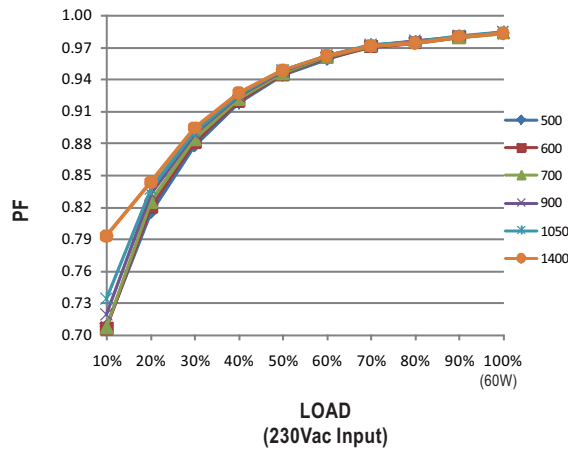

EFFICIENCY vs LOAD

LCM-60KN series possess superior working efficiency that up to 91% can be reached in field applications.

※ Tcase at 80°C

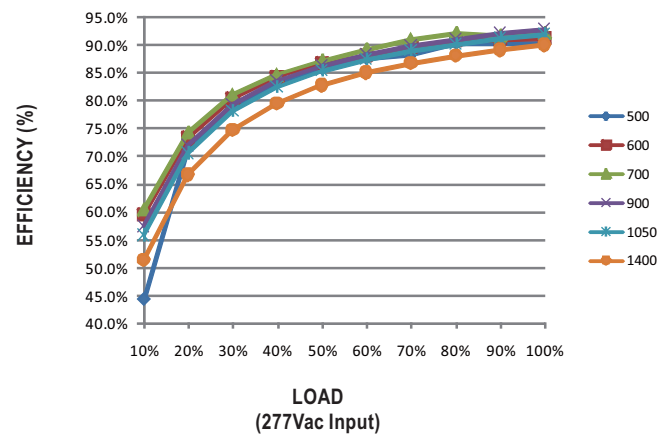
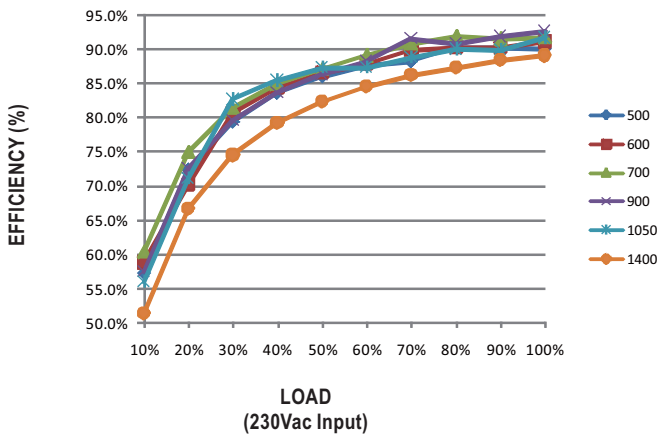

MECHANICAL SPECIFICATION

Case No. LCM-60B Unit:mm

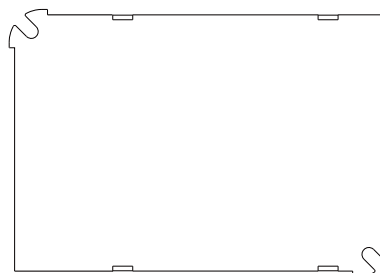
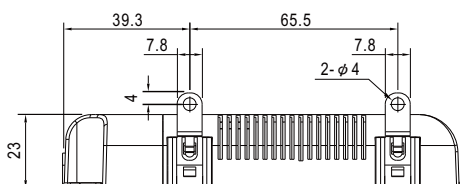
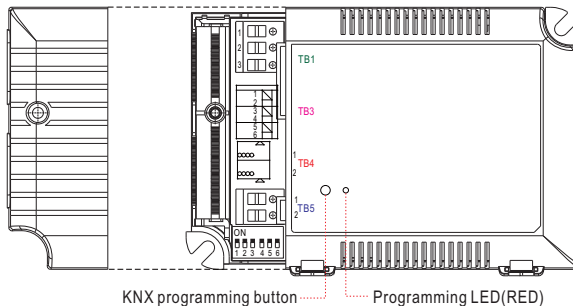
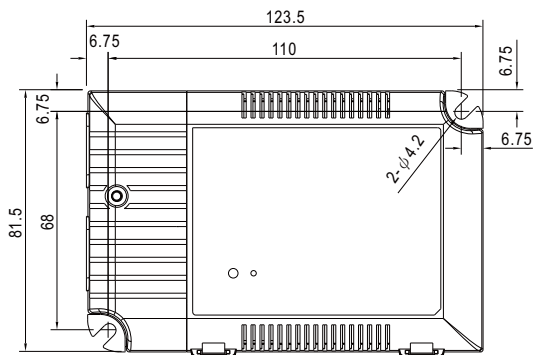

Bottom View

※ Terminal Pin No. Assignment(TB1)

Pin No.	Assignment
1	AC/L
2	AC/N
3	PUSH

※ Terminal Pin No. Assignment(TB3)

Pin No.	Assignment	Pin No.	Assignment	Pin No.	Assignment
1	+FAN(optional)	3	+NTC	5	+SYN
2	-FAN(optional)	4	-NTC	6	-SYN

◎ Pin1(+FAN) / Pin2(-FAN) is the Auxiliary DC output for the optional model LCM-60KN-AUX; it can be used to drive fan.

※ Terminal Pin No. Assignment(TB4)

Pin No.	Assignment
1	KNX-
2	KNX+

※ Terminal Pin No. Assignment(TB5)

Pin No.	Assignment
1	+V
2	-V