

# Intelligent VS Power

Up to 4920 Watts

## Data Sheet

**Total Power:** Up to 4920 W  
**Input Voltage:** 85 - 264 Vac  
 380, 440 Vac  
 120 - 300 Vdc  
 1-Phase  
 3-Phase  
**# of Outputs:** Up to 24

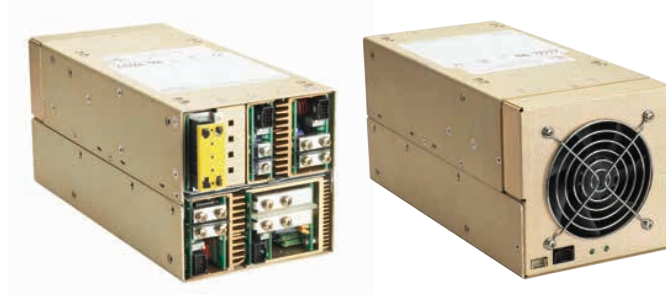

**iVS™**

**PMBus®**  
Power Management. Defined.

## SPECIAL FEATURES

- Full medical EN60601 approval\*
- Intelligent I<sup>2</sup>C control
- Voltage adjustment on all outputs (manual or I<sup>2</sup>C)
- Configurable input and output OK signals and indicators
- Configurable inhibit/enable
- Configurable output UP/DOWN sequencing
- High power density (12 W/cu-in)
- Intelligent fan (speed control/fault status)
- uP controlled PFC input with active Inrush protection
- I<sup>2</sup>C monitor of voltage, current, and temperature
- Programmable voltage, current limit, inhibit/enable through I<sup>2</sup>C
- Optional extended hold-up module (SEMI F47 compliance)
- Increased power density to 150%
- Optional conformal coating
- Industrial temp range (-40 °C to 70 °C)
- Uses standard iMP modules
- Field upgradeable firmware
- RoHS compliant

## SAFETY

- UL UL60950/UL2601
- CSA CSA22.2 No. 234 Level 5
- UV EN60950/EN60601-1
- BABT Compliance to EN60950/EN60601 BS7002
- CB Certificate and report
- CE Mark to LVD

\* Note: iVS8H does not have Medical or MOPP approvals.

## Electrical Specifications

Input	
Input range	iVS1 & iVS3 90 - 264 Vac 1Ø; 120 - 300 Vdc
	iVS6 & iVS8 170 - 264 Vac 3Ø
	iVS8H 396 - 480 Vac rated at 4920 W DC output 3Ø 342 - 480 Vac rated at 4200 W DC output 3Ø
Frequency	47 - 63 Hz
Inrush current	40 A peak maximum (soft start)
Efficiency	Up to 85% @ full case load
Power Factor	0.99 typ. meets EN61000-3-2
Turn-on time	AC on 1.5 sec typical, inhibit/enable 150ms typical Programmable; 50 ms internal turn-on delay (Dual Output only)
EMI Filter	CISPR 22/EN55022 Level "B". Level "A" for iVS8H
Leakage current	500 µA max. @ 240 Vac; 47-63 Hz
Radiated EMI	CISPR 22/EN55022 Level "B". Level "A" for iVS8H
Holdover storage	10 ms minimum (independent of input Vac) additional 20 mSEC holdover storage with optional HUP module (SEMI F47 compatible)
AC OK	> 5 ms early warning minutes before outputs lose regulation Full cycle ride thru (50 Hz). Programmable
Harmonic distortion	Meets EN61000-3-2
Isolation	Meets EN60950 and EN60601 Meets 1 MOPP Primary to ground, 2 MOPP Primary to Secondary*
Global inhibit / enable	TTL, Logic "1" and Logic "0"; configurable
Warranty	3 years

## Electrical Specifications

Output	
<b>Adjustment range*</b>	± 10% minimum all outputs (manual) (full module adjustment range using I <sup>2</sup> C)
Factory set point accuracy	1%
I <sup>2</sup> C output program accuracy	± 5%
Margining	± 4 - 6% nominal analog (single output module only)
Overall regulation	0.4% or 20 mV max. (1500 W modules 1% max.)
Ripple	RMS: 0.1% or 10 mV, whichever is greater Pk-Pk: 1.0% or 50 mV, whichever is greater Bandwidth limited to 20 MHz
Dynamic response	< 2% or 100 mV, with 25% load step
Recovery time	To within 1% in < 300 μsec
<b>Overcurrent protection**</b>	Configurable through I <sup>2</sup> C (calibration required). Single output module and main output of the dual output module 105 - 120% of rated output current. Aux output of dual output module 105 - 140% of rated output current. Special programmable OCP delay on 1500 W module from 100 mSec to 25.5 seconds with shutdown features.
Short-circuit protection	Protected for continuous short-circuit. Recovery is automatic upon removal of short (Shutdown mode on 1500 W module).
<b>Overvoltage protection*</b>	Configurable through I <sup>2</sup> C
	Single output module: 2 - 5.5 V 122 - 134%; 6 - 60 V 110 - 120%
	Dual output module: 2 - 6 V 122 - 134%; 8 - 28 V 110 - 120%
	Triple output module: 110 - 120% of highest voltage rating
<b>Thermal protection*</b>	Configurable through I <sup>2</sup> C All outputs disabled when internal temp exceeds safe operating range. > 5 ms warning (AC OK signal) before shutdown
Remote sense	Up to 0.5 V total drop (not available on triple output module)
Single wire parallel	Current share to within 2% of total rated current
DC OK*	± 5% of nominal. Configurable through I <sup>2</sup> C
Minimum load	Not required
Housekeeping bias voltage	5 Vdc @1.0 A max. present whenever AC input is applied Overall Regulation: ± 5% Ripple and Noise: 150 mV pk-pk, Bandwidth limited to 150 MHz and measured with 10 uF Tantalum capacitor and 0.1 uF ceramic capacitor in parallel on the output.
<b>Module inhibit*</b>	Configured and controlled through I <sup>2</sup> C
Output/Output isolation	> 1 Megohm, 500 V

\* Can be controlled via I<sup>2</sup>C

\*\* Controlled via I<sup>2</sup>C but requires load calibration (except 1500 W module)

## Environmental Specifications

<b>Operating temperature</b>	-40 ° to 70 °C ambient. Derate each output 2.5% per degree from 50 ° to 70 °C. (-20 °C start up)
<b>Storage temperature</b>	-40 °C to +85 °C
<b>Electromagnetic susceptibility</b>	Designed to meet EN61000-4; -2, -3, -4, -5, -6, -8, -11 Level 3
<b>Humidity</b>	Operating; non-condensing 10% to 95% RH
<b>Vibration</b>	IEC68-2-6 to the levels of IEC721-3-2
<b>MTTF field demonstrated</b>	> 550,000 hours at full load, 220 Vac and 25 °C ambient conditions

### Output Module Line-up

Module Code	1	2	3	5	4		—
Module Type	Single	Single	Single	Single	Dual		Triple
Max output power	210 W	360 W	750 W	1500 W	144 W		36 W
Max output current	35 A	60 A	150 A	300 A	10 A		2 A
Output voltages available*	2 - 60 V	2 - 60 V	2 - 60 V	2 - 60 V	8 - 15*, 24 - 28; 8 - 15*, 8 - 15*; 8 - 15*, 2 - 6; 2 - 6, 2 - 6; 24 - 28, 24 - 28; 24 - 28, 2 - 6		8 - 15, 8 - 15, 2 - 6; 8 - 15, 8 - 15, 8 - 15; 8 - 15, 8 - 15, 18 - 28; 8 - 15, 18 - 28, 2 - 6
Standard voltage increments	25	25	25	25	16		18
Remote sense	Yes	Yes	Yes	Yes	Yes	Yes	No
Remote margin	Yes	Yes	Yes	Yes	No	No	No
V-Program - I <sup>2</sup> C Control	Yes	Yes	Yes	Yes	Yes	Yes	No
Active Current Share	Yes	Yes	Yes	Yes	Yes	No	No
Module Inhibit - I <sup>2</sup> C Control	Yes	Yes	Yes	Yes	Yes	Yes	Yes
Module Inhibit - Analog	Yes	Yes	Yes	Yes	Yes	No	No
Overvoltage/Overcurrent protection	Yes	Yes	Yes	Yes	Yes	Yes	Yes
Minimum load required	No	No	No	No	No	No	No
Slots occupied in any iVS case	1	2	3	4	1		1

\* Note: Contact Factory for extended range down to 6 V

### Single



210 W



750 W

### Dual



144 W

### Triple



36 W



360 W



1500 W (2.0 - 8.0 V)



1500 W (10 - 60 V)



1500 W with Bus Bar Adaptor Option  
(used with the 10 - 60 V module)

### Output Module Voltage/Current\*

Voltage	Voltage Code	Single Output Module Code				Dual Output***		Triple Output			I <sup>2</sup> C Adjustment Ranges****
		1	2	3	5	4	4	-	-	-	
2 V	A	35 A	60 A	150 A	300 A	10 A	10 A	—	—	2 A	1.8 - 2.2
2.2 V	B	35 A	60 A	150 A	300 A	10 A	10 A	—	—	2 A	2.0 - 2.4
3 V	C	35 A	60 A	150 A	300 A	10 A	10 A	—	—	2 A	2.7 - 3.3
3.3 V	D	35 A	60 A	150 A	300 A	10 A	10 A	—	—	2 A	3.0 - 3.6
5 V	E	35 A	60 A	150 A	300 A	10 A	10 A	—	—	2 A	4.5 - 5.5
5.2 V	F	35 A	60 A	144 A	288 A	10 A	10 A	—	—	2 A	4.7 - 5.7
5.5 V	G	34 A	58 A	136 A	273 A	10 A	10 A	—	—	2 A	5.0 - 6.1
6.0 V	H	23 A	42 A	97.5 A	250 A	10 A*	10 A*	—	—	2 A	5.4 - 6.6
8.0 V	I	20 A	36 A	84.4 A	187.5 A	10 A	4 A	1 A	1 A	1 A	7.2 - 8.8
10 V	J	18 A	32 A	75 A	140 A	10 A	4 A	1 A	1 A	1 A	9.0 - 11.0
11 V	K	17 A	31 A	68 A	136.3 A	10 A	4 A	1 A	1 A	1 A	9.9 - 12.1
12 V	L	17 A	30 A	62.5 A	125 A	10 A	4 A	1 A	1 A	1 A	10.8 - 13.2
14 V	M	14 A	21 A	53.5 A	107 A	9 A	4 A	1 A	1 A	1 A	12.6 - 15.4
15 V	N	14 A	20 A	50 A	100 A	8 A	4 A	1 A	1 A	1 A	13.5 - 16.5
18 V	O	11 A	19 A	41.6 A	83.3 A	—	—	—	0.5 A	0.5 A	16.2 - 19.8
20 V	P	10.5 A	18 A	37.5 A	75 A	—	—	—	0.5 A	0.5 A	18.0 - 22.0
24 V	Q	8.5 A	15 A	30 A	62.5 A	4 A	2 A	—	0.5 A	0.5 A	21.6 - 26.4
28 V	R	6.7 A	11 A	26.8 A	53.5 A	3 A	2 A	—	0.5 A	0.5 A	25.2 - 30.8
30 V	S	6.5 A	11 A	25 A	50 A	—	—	—	—	—	27.0 - 33.0
33 V	T	6.2 A	10.9 A	22.7 A	35.8 A	—	—	—	—	—	29.7 - 36.3
36 V	U	5.8 A	10 A	20.8 A	35.8 A	—	—	—	—	—	32.4 - 39.6
42 V	V	4.2 A	7.5 A	16 A	35.7 A	—	—	—	—	—	37.8 - 46.2
48 V	W	4.0 A	7.5 A	15.6 A	31.2 A	—	—	—	—	—	43.2 - 52.8
54 V	X	3.7 A	6.0 A	13.9 A	27.7 A	—	—	—	—	—	48.6 - 59.4
60 V	Y	3.5 A	6.0 A	12.5 A	25 A	—	—	—	—	—	54.0 - 66.0
<b>Contact Factory</b>											
Special*	Z	35 A	60 A	150 A	300 A	—	10 A				2.3 - 2.6
Special*	Z	35 A	60 A	150 A	300 A	—	10 A				3.7 - 4.4
Special*	Z	20 A	36 A	80 A	140 A	—	8 A				6.7 - 7.1

\* Note: Contact Factory for extended range down to 6 V.

\*\* Increments of current not shown can be achieved by paralleling modules (add currents of each module selected).

\*\*\* Total output power on dual model must not exceed 144 W.

\*\*\*\* For single output modules only.

Green reference lines indicate physical module groupings

### Ordering Information

Sample below is 3210 W case with 12 V @ 125 A; 24 V @ 8.5 A; 5 V @ 60 A; 12 V @ 10 A and 12 V @ 4 A; with no options.

Case Size	Module/Voltage/Option Codes	Case Option Codes	Software Code	Hardware Code
<p><b>iVS1</b></p> <p><b>Case Size (mm)</b>  <b>1-Phase Input</b>            1 = 5" x 5" x 11"; 1500 W - 3210 W, 9 Slots            (127 x 127 x 279.4 mm)            3 = 5" x 8" x 11"; 1800 W - 4500 W, 14 Slots            (127 x 203.2 x 279.4 mm)  <b>3-Phase Input</b>            6 = 5" x 5" x 11"; 3120 W, 9 Slots            (127 x 127 x 279.4)            8, 8H = 5" x 8" x 11"; 4920 W, 14 Slots            (127 x 203.2 x 279.4 mm)</p>	<p><b>5L1 - 1Q1 - 2EO - 4LL0</b></p> <p><b>Module Codes:</b>            (None) = 36 W triple O/P (1 slot)            1 = 210 W single O/P (1 slot)            2 = 360 W single O/P (2 slot)            3 = 750 W single O/P (3 slot)            5 = 1500 W single O/P (slot 4)            4 = 144 W dual O/P (1 slot)            HUP = Extra 30mS hold-up (1 slot)  <b>Voltage Codes:</b>            See Output Module Voltage/Current table  <b>Option Codes:</b>            0 = Standard            1 = Module enable            2 = Constant current            3 = 1 &amp; 2 combined            4 = Set for use in standard (non-intelligent case)            5 = Shutdown mode for 1500 W            6 = 1 &amp; 5 combined            7-9 Future</p>	<p><b>00</b></p> <p><b>First Digit</b>            0 - 9, A - Z Parallel code            (See parallel codes table below)  <b>Second Digit</b>            0 = No options            1 = Reverse air            2 = Not used            3 = Global enable            4 = Fan Idle w/inhibit            5 = Opt 1 + Opt 3            6 = Opt 1 + Opt 4            7 = Opt 3 + Opt 4            8 = Opt 1 + 3 + 4            9 = RS485 73-544-001            B = USB 73-546-001            C = 9 + 3            D = CANBUS 73-544-004            E = D + 3            F = RS485 - MODBUS 73-544-005</p>	<p><b>A</b></p> <p>Software code used for configuration change. "A" is standard</p>	<p><b>###</b></p> <p>Factory assembled for hardware of firmware mods.</p>

**Ordering Note:**

1. USB to I<sup>2</sup>C module order code 73-769-001

### Ordering Information

Parallel Code	Slot No.	iVS1, 6		iVS3, 8H	
		Diagram	Possible Configurations	Diagram	Possible Configurations
1	1 & 2		210 210; 210 144; 144 144		210 210; 210 144; 144 144
2	2 & 3		360 360; 360 210; 360 144; + above		360 360; 360 210; 360 144; + above
3	3 & 4		750 360; 750 210; 750 144; 210 210; 210 144; 144 144		750 750; 750 360; 750 210; 750 144; 210 210; 210 144; 144 144
4	4 & 5		1500 210; 1500 144; 210 210; 210 144; 144 144; 360 210; 360 144		1500 1500; 1500 750; 1500 360; 1500 210; 1500 144; 210 210; 210 144; 144 144; 360 360; 360 210; 360 144
5	3, 4, & 5		750 210 210; 750 210 144; 750 144 144		750 210 210; 750 210 144; 750 144 144
6	iVS1,6: 4 & 6		1500 1500; 1500 750		
7	4, 5, & 6		1500 210 210; 1500 210 144; 1500 144 144; 1500 210 1500		1500 210 210; 1500 210 144; 1500 144 144
8	iVS1,6: 3 & 6 iVS3,8: 4, 5, & 9		750 750		1500 1500 1500; 1500 1500 750; 1500 1500 360; 1500 1500 210; 1500 1500 144
9	iVS1,6: 1 & 6 iVS3, 8: 4, 5 & 9; 12 & 13		1500 1500; 1500 360; 1500 144		1500 1500 1500 360; 1500 1500 1500 210; 1500 1500 1500 144
A	iVS1,6: 3 & 4; 8 & 9 iVS3, 8: 4 & 5; 11 & 12		750 210 & 750 210		1500 1500 & 750 750
C	iVS1,6: 3, 4 & 6 iVS3, 8: 6 & 7; 3, 4, 11 & 12		750, 360, 750		750 750 360 750 750
E	iVS1,6: 3, 4, 6; 8 & 9 iVS3, 8: 3, 4, 11, & 12		750, 360, 750, 210		750 750 750 750
F	iVS1,6: 7-8 iVS3, 8: 3 & 4; 11 & 12		360, 360		750 360 & 750 210; 750 750 & 750 750
G	iVS3, 8: 3, 4 & 9				750 750 750
H	iVS3, 8: 11 & 12				750 750
J	iVS3, 8: 4 & 5; 9 & 10				1500 210 & 210 1500
K	iVS3, 8: 1 & 9; 5 & 12				1500 750 & 1500 750
L	iVS3, 8: 3 & 4; 7 & 8; 9 & 10				750 210 & 750 210 & 210 1500
M	iVS3, 8: 3, 4 & 9; 6 & 7				750 750 360 750
N	iVS3, 8: 4, 5 & 9; 12, 13 & 14				1500, 1500, 1500, 210, 210
P	iVS3, 8: 1 & 9				1500, 750

## iVS Case Specifications

### iVS1 and iVS6

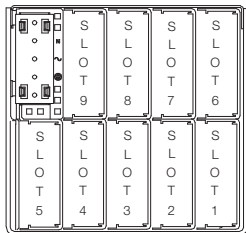

Model	Dimensions (mm)	Slots	Input	Power
iVS1	5" x 5" x 11" (127 x 127 x 279.4 mm)	9 available slots	90 - 264 Vac 1500 W max.	170 - 264 Vac 3210 W max.
iVS6	5" x 5" x 11" (127 x 127 x 279.4 mm)	9 available slots 3-phase only	N/A	170 - 264 Vac 3210 W max.

### iVS3, iVS8 and iVS8H

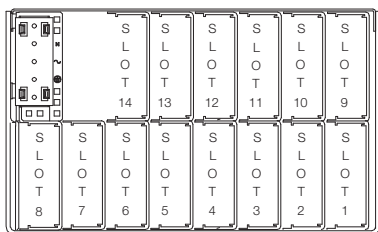

Model	Dimensions (mm)	Slots	Input	Power
iVS3	5" x 8" x 11" (127 x 203.2 x 279.4 mm)	14 available slots	90 - 264 Vac 1800 W max.	170 - 264 Vac 4500 W max.
iVS8	5" x 8" x 11" (127 x 203.2 x 279.4 mm)	14 available slots	N/A	170 - 264 Vac 4920 W max.
iVS8H	5" x 8" x 11" (127 x 203.2 x 279.4 mm)	14 available slots	342 - 480 Vac (440 nominal) 4200W max	396 - 480 Vac (440 nominal) 4920W max

## Pin Connectors

Figure 1. AC Input

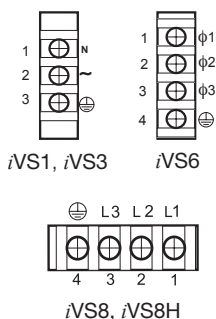

AC Input	Single Phase	3 Phase
<i>Pin</i>	<i>Function</i>	
1	AC neutral	Line 1
2	AC line (hot)	Line 2
3	Chassis (earth) ground	Line 3
4	Not used	Chassis (earth) ground

Figure 2. Connector J1

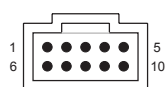

Mates with  
Molex 90142-0010 Housing  
90119-2110 Pin

Connector Kit Part No.:  
70-841-004

PFC Input Connector (control & signals)	
<i>Pin</i>	<i>Function</i>
1	Input AC OK - "emitter"
2	Input AC OK - "collector"
3	Global DC OK - "emitter"
4	Global DC OK - "collector"
5	Spare
6	Global inhibit/optional enable logic "0"
7	Global inhibit/optional enable logic "1"
8	Global inhibit/optional enable return
9	+5 VSB housekeeping
10	+5 VSB housekeeping return

Figure 3. Connector J2

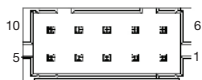

Mates with  
Landwin 2050S1000 Housing  
2053T011V Pin

or

JST PHDR-10VS Housing  
JST SPHD-002T-P0.5 (28-24)  
JST SPHD-001T-P0.5 (26-22)

Connector Kit Part No.:  
70-841-023

I <sup>2</sup> C Bus Output Connector	
<i>Pin</i>	<i>Function</i>
1	No connection
2	No connection
3	No connection
4	Serial clock signal (SCL)
5	Serial data signal (SDA)
6	Address bit 0 (A0)
7	Address bit 1 (A1)
8	Address bit 2 (A2)
9	Secondary return (GND)
10	+5 VCC external bus (+5 VCC bus)

## Mechanical Drawings

### iMP Modules

#### DC-DC Converter Output Modules

Control Signal Information, J1 Control Connector		
Pin No.	Function	
1	+ Remote Sense	single or dual o/p main
2	Remote Margin / V. Program	single o/p
3	Margin High	single o/p
4	- Remote Sense / Margin Low	single or dual o/p main
5	Spare	
6	Module, Isolated Inhibit	single or dual o/p
7	Module Inhibit Return	single or dual o/p
8	Current Share (SWP)	single or dual o/p main
9	+ Remote Sense V2	dual o/p, single is spare
10	- Remote Sense V2	dual o/p, single is spare

\* Note: All iMP modules have a green DCOK LED. (except for 36 W module)

Figure 4. Connector J1

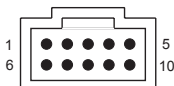

Mates with  
Molex 90142-0010 Housing  
90119-2110 Pin

#### Single 210 Watt

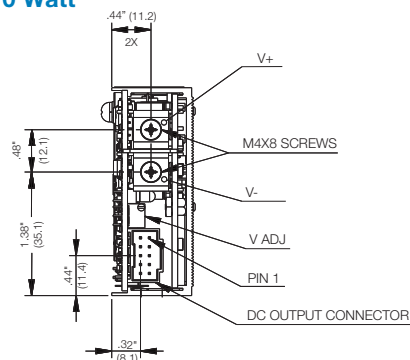

#### Single 360 Watt

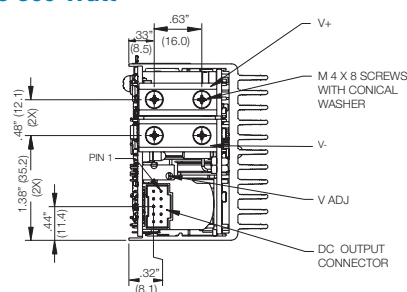

#### Single 750 Watt

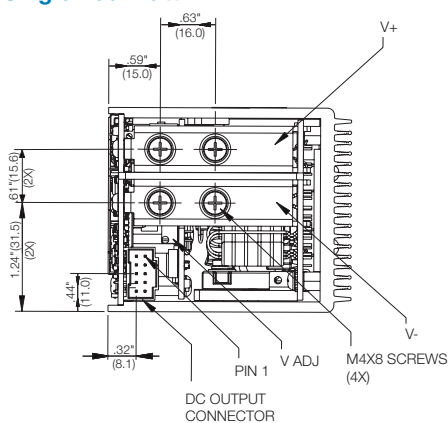

#### Single 1500 Watt 2-8 V

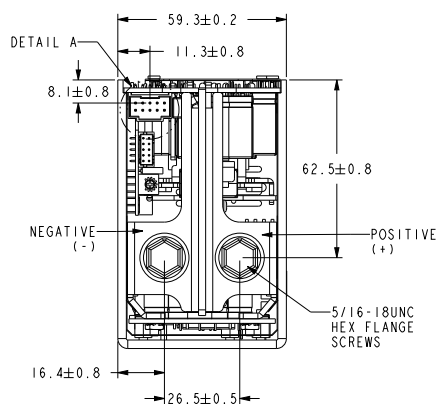

#### Single 1500 Watt 10-60 V

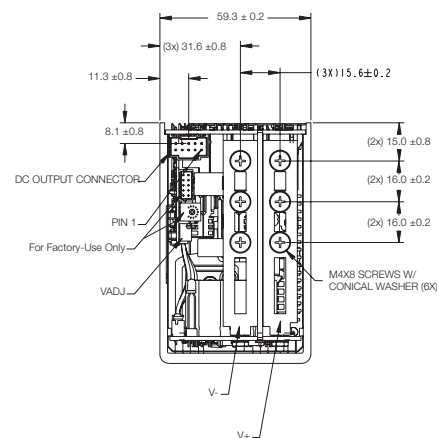

#### Dual 144 Watt

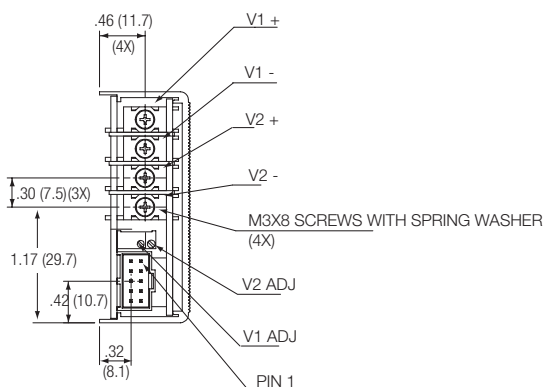

#### Triple 36 Watt

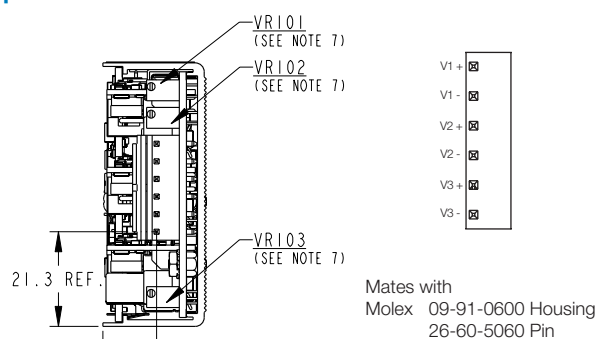

## iVS Series

### iVS1 (1500/3210 Watts Max)

5-Inch Case Size: iVS1: 5" x 5" x 11" (127 mm x 127 mm x 279.4 mm)

Weight: iVS1 Case: 6.2 lbs. • 1500 W Single: 2.0 lbs. • 750 W Single: 1.6 lbs.  
• 360 W Single: 1.0 lb. • 210 W Single: 0.6 lb. • 144 W Dual: 0.6 lb.

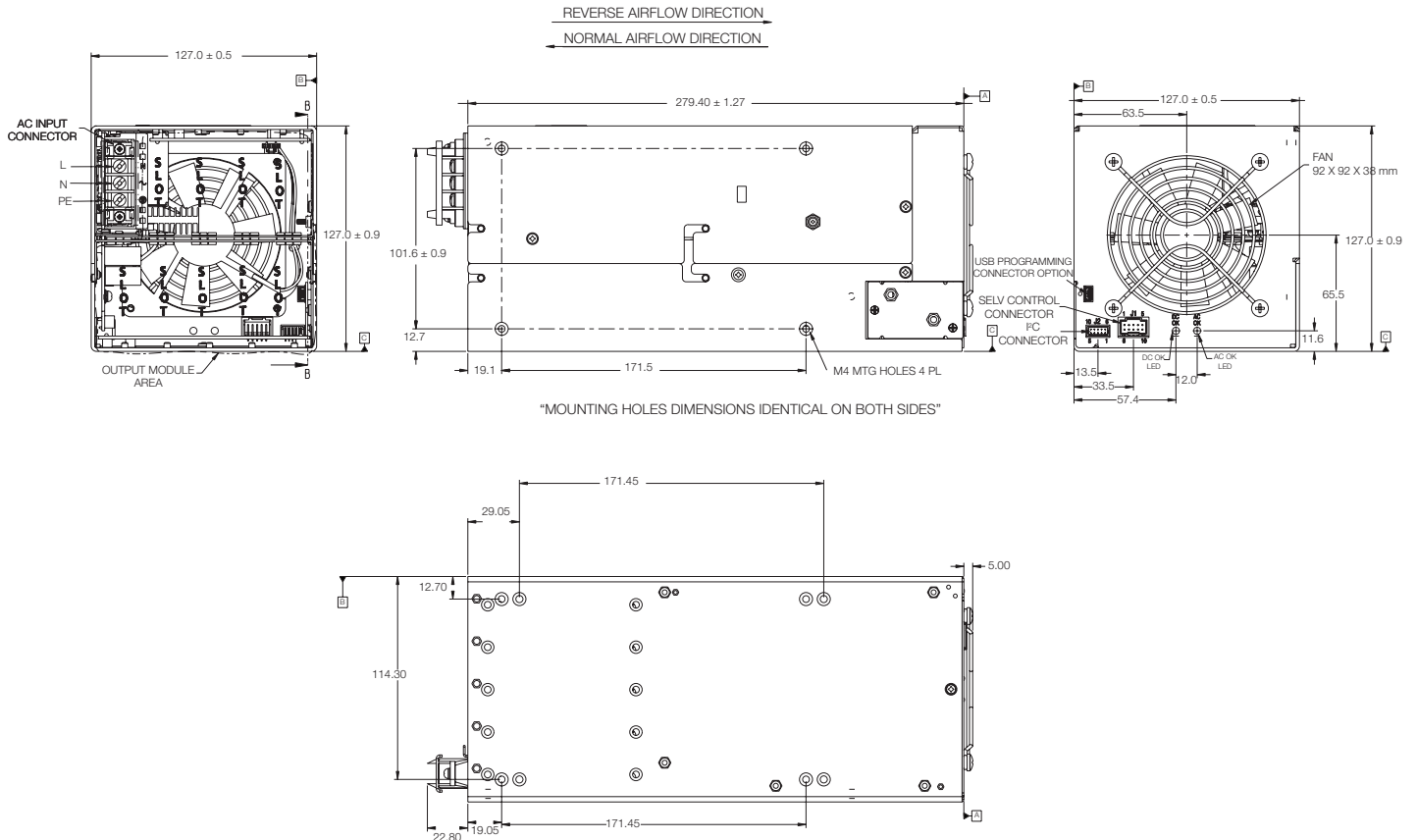

#### Notes:

1. Input: Barrier type. Three No. 6-32 B.H. screws (0.375" centers). Max torque: 6 in-lbs. (0.67 N-m).
2. Control connectors: (J1) 10 position housing, gold plated contacts. Mates with Molex 90142-0010 housing with 90119-2110 crimp contacts (Molex C - Grid III Series). Connector kit includes mating connector and 10 pins, Astec part #70-841-004. (J2) 10 position housing (Landwin 2051P1000T). Mates with housing 2050S1000 (Landwin) with 2053T011P (Landwin) pins.
3. Chassis material: aluminum with chemical film coating (conductive).
4. All dimensions are in millimeters and inches, and are typical.
5. Customer mounting -3 sides M4, bottom also includes 8-32 mounting holes. Max. penetration is 0.155" (4.0 mm). Max. torque: 5 in-lbs. (0.57 N-m).
6. Output module connections: All single O/P modules are M4 x 8 mm screws. Max. torque: 10 in-lbs. (1.13 N-m). Dual O/P module is M3 x 8 mm screws. Max. torque: 5 in-lbs. (0.57 N-m).



**iVS Series**

**iVS3 (1800/4500 Watts Max)**

8-Inch Case Size: iVS3: 5" x 8" x 11" (127 mm x 203.2 mm x 279.4 mm)

Weight: iVS3 Case: 9.0 lbs. • 1500 W Single 2.0 lbs. • 750 W Single: 1.6 lbs.  
• 360 W Single: 1.0 lb. • 210 W Single: 0.6 lb. • 144 W Dual: 0.6 lb.

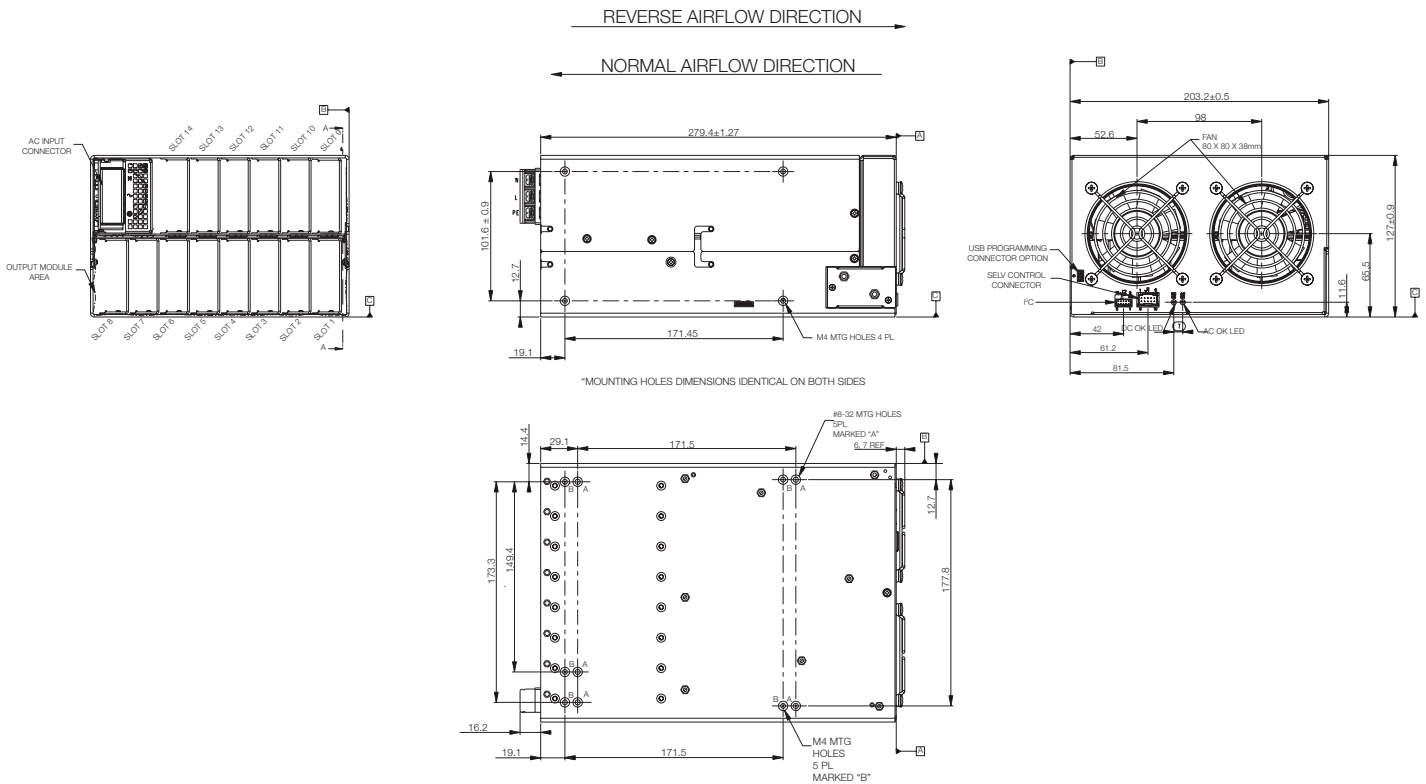

**Notes:**

1. Input: Barrier type. Three M4 screws (0.512" centers). Max torque: 7 in-lbs. (0.79 N-m).
2. Control connectors: (J1) 10 position housing, gold plated contacts. Mates with Molex 90142-0010 housing with 90119-2110 crimp contacts (Molex C - Grid III Series). Connector kit includes mating connector and 10 pins, Astec part #70-841-004. (J2) 10 position housing (Landwin 2051P1000T). Mates with housing 2050S1000 (Landwin) with 2053T011P (Landwin) pins.
3. Chassis material: aluminum with chemical film coating (conductive).
4. All dimensions are in millimeters and inches, and are typical.
5. Customer mounting -3 sides M4, bottom also includes 8-32 mounting holes. Max. penetration is 0.155" (4.0 mm). Max. torque: 5 in-lbs. (0.57 N-m).
6. Output module connections: All single O/P modules are M4 x 8 mm screws. Max. torque: 10 in-lbs. (1.13 N-m).  
Dual O/P module is M3 x 8 mm screws. Max. torque: 5 in-lbs. (0.57 N-m).

## iVS Series

### iVS6 (3210 Watts Max)

5-Inch Case Size: iVS6: 5" x 5" x 11" (127 mm x 127 mm x 279.4 mm)

Weight: iVS6 Case: 6.0 lbs. • 1500 W Single 2.0 lbs. • 750 W Single: 1.6 lbs.  
• 360 W Single: 1.0 lb. • 210 W Single: 0.6 lb. • 144 W Dual: 0.6 lb.

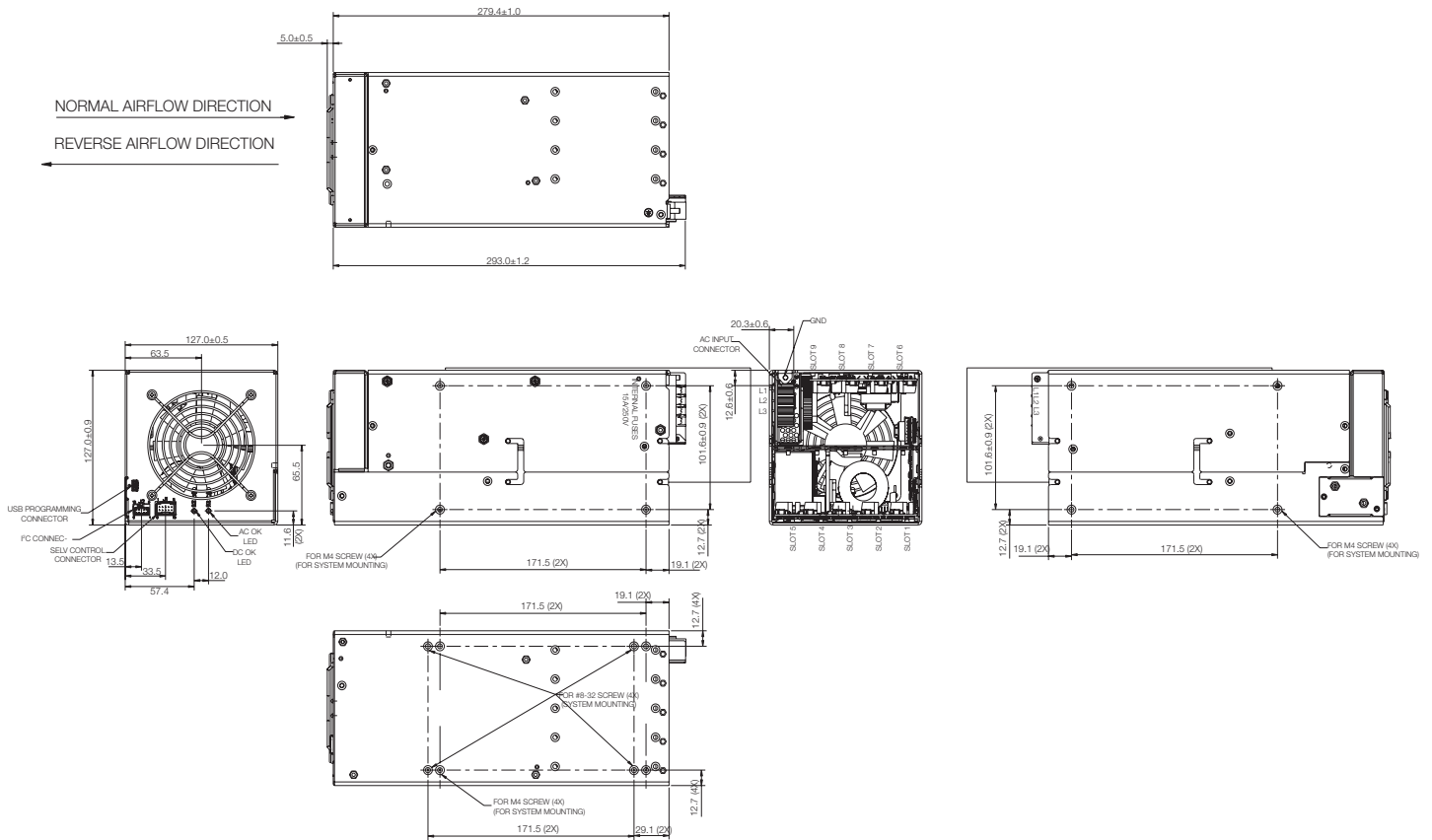

#### Notes:

- Input: Barrier type. Four M3 screws (0.325" centers). Max torque: 6 in-lbs. (0.67 N-m).
- Control connectors: (J1) 10 position housing, gold plated contacts. Mates with Molex 90142-0010 housing with 90119-2110 crimp contacts (Molex C - Grid III Series). Connector kit includes mating connector and 10 pins, Astec part #70-841-004. (J2) 10 position housing (Landwin 2051P1000T). Mates with housing 2050S1000 (Landwin) with 2053T011P (Landwin) pins.
- Chassis material: aluminum with chemical film coating (conductive).
- All dimensions are in millimeters and inches, and are typical.
- Customer mounting -3 sides M4, bottom also includes 8-32 mounting holes. Max. penetration is 0.155" (4.0 mm). Max. torque: 5 in-lbs. (0.57 N-m).
- Output module connections: All single O/P modules are M4 x 8 mm screws. Max. torque: 10 in-lbs. (1.13 N-m). Dual O/P module is M3 x 8 mm screws. Max. torque: 5 in-lbs. (0.57 N-m).

## iVS Series

**iVS8 (4920 Watts Max)**  
**iVS8H (4920 Watts Max)**

8-Inch Case Size: iVS8: 5" x 8" x 11" (127 mm x 203.2 mm x 279.4 mm)

Weight: iVS8 Case: 9.0 lbs. • 1500 W Single 2.0 lbs. • 750 W Single: 1.6 lbs.  
• 360 W Single: 1.0 lb. • 210 W Single: 0.6 lb. • 144 W Dual: 0.6 lb.

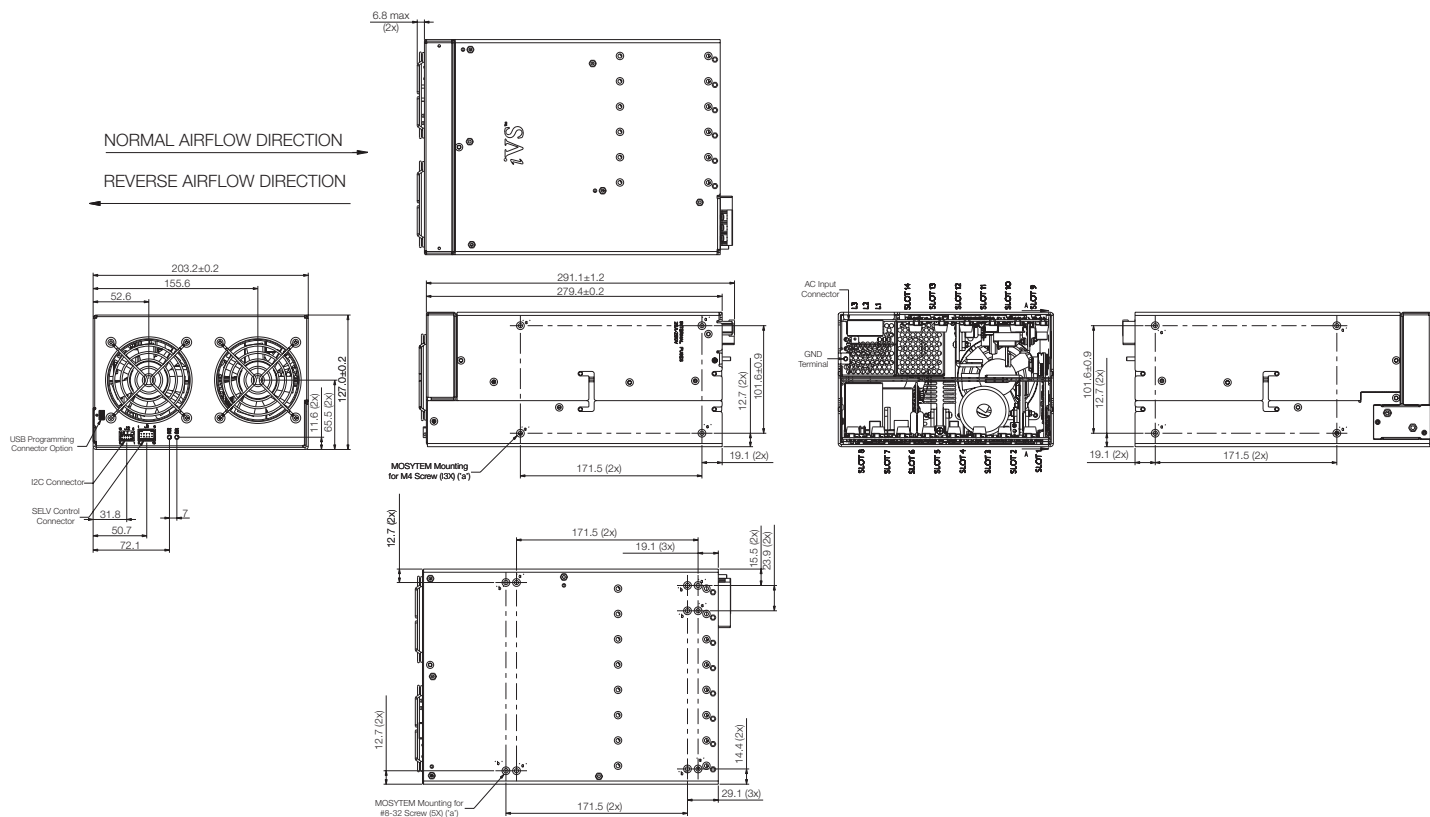

### Notes:

1. Input: Barrier type. Three M3.5 screws (0.394" centers). Max torque: 6 in-lbs. (0.67 N-m).
2. Control connectors: (J1) 10 position housing, gold plated contacts. Mates with Molex 90142-0010 housing with 90119-2110 crimp contacts (Molex C - Grid III Series). Connector kit includes mating connector and 10 pins, Astec part #70-841-004. (J2) 10 position housing (Landwin 2051P1000T). Mates with housing 2050S1000 (Landwin) with 2053T011P (Landwin) pins.
3. Chassis material: aluminum with chemical film coating (conductive).
4. All dimensions are in millimeters and inches, and are typical.
5. Customer mounting -3 sides M4, bottom also includes 8-32 mounting holes. Max. penetration is 0.155" (4.0 mm). Max. torque: 5 in-lbs. (0.57 N-m).
6. Output module connections: All single O/P modules are M4 x 8 mm screws. Max. torque: 10 in-lbs. (1.13 N-m). Dual O/P module is M3 x 8 mm screws. Max. torque: 5 in-lbs. (0.57 N-m).

## Optional CANBUS or RS485 Interface

The RS485/CAN-to-I<sup>2</sup>C uses 2 Input Protocols and 1 Output Protocol.

The Input Protocols used are RS485 using Modbus (Command Index: 0x01), and CAN using modified Modbus (Command Index: 0x02).

The Output Protocol use is: I<sup>2</sup>C with SMBus support (Command Index: 0x80).

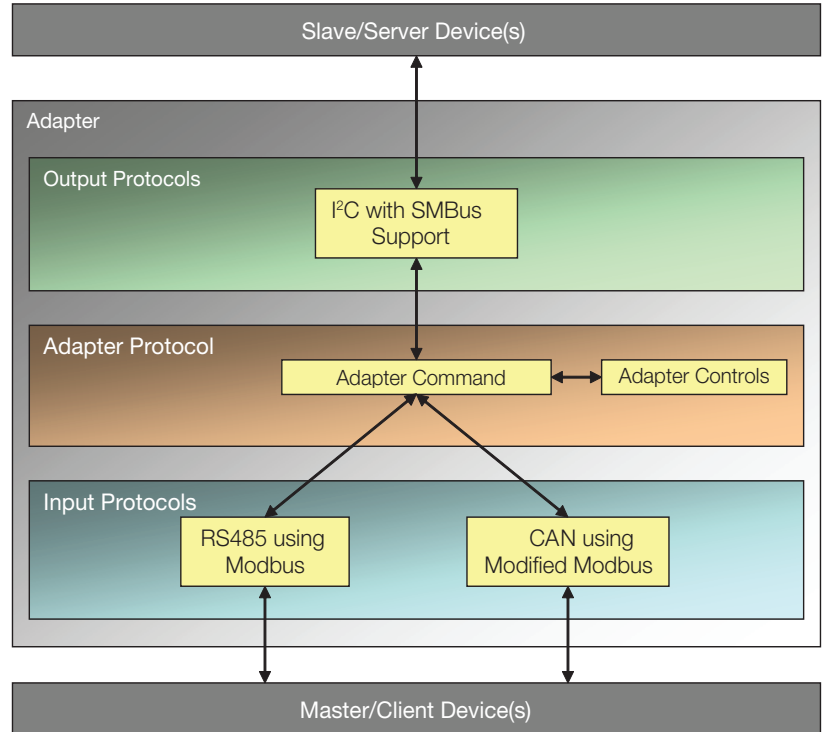

### RS485/CAN - to - I<sup>2</sup>C

For detailed info, download the Software Requirements Specification (SRS) from <http://www.artesyn.com/power/power-supplies/category.php?catID=103>

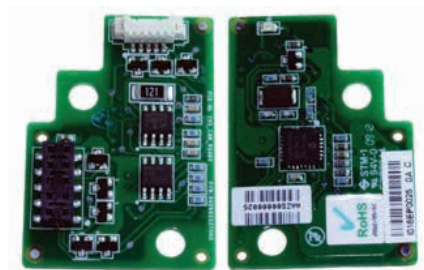

iVS CAN RS485

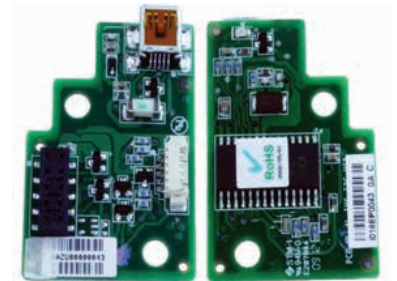

iVS I<sup>2</sup>C USB