



■ Features

- Constant Current mode output
- Metal housing with Class I design
- Built-in active PFC function
- Environment-adaptive driving capability
- IP67 / IP65 design for indoor or outdoor installations
- Function options: output adjustable via potentiometer; 3 in 1 dimming (dim-to-off, isolated design); Smart timer dimming; Low temperature light-on; Junction box
- Typical lifetime > 62000 hours (Note.7)
- 7 years warranty

■ Applications

- LED Harbour
- LED greenhouse lighting
- LED stadium lighting
- LED mining lighting
- Type "HL" for use in Class I, Division 2 hazardous (Classified) location

■ Description

HLG-480H-C series is a 480W LED AC/DC driver featuring the constant current mode and high voltage output. HLG-480H-C operates from 90~305VAC and offers models with different rated current ranging between 1400mA and 3500mA. Thanks to the high efficiency up to 95%, with the fanless design, the entire series is able to operate for -40°C ~ +90°C case temperature under free air convection. The design of metal housing and IP67/IP65 ingress protection level allows this series to fit both indoor and outdoor applications. Moreover, the innovative environment-adaptive capability allows this series to reliably light on the LEDs for all kinds of application environments in almost any spots that may install LED luminaires in the world. HLG-480H-C is equipped with various function options, such as dimming methodologies, so as to provide the optimal design flexibility for LED lighting system.

■ Model Encoding

HLG - 480H - C1400 A

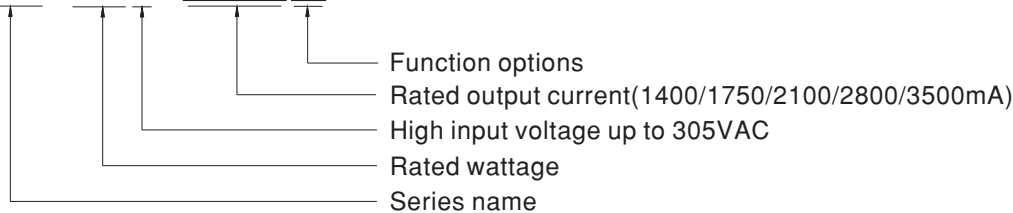

Type	IP Level	Function	Note
A	IP65	o adjustable through built-in potentiometer. And environment adaptiveness.	In Stock
B	IP67	3 in 1 dimming function (0~10Vdc, 10V PWM signal and resistance) and environment adaptiveness.	In Stock
AB	IP65	Io adjustable through built-in potentiometer & 3 in 1 dimming function (0~10Vdc, 10V PWM signal and resistance)	In Stock
Dx	IP67	Built-in Smart timer dimming function by user request. And environment adaptiveness.	By request
D2	IP67	Built-in Smart timer dimming and programmable function. And environment adaptiveness.	In Stock

File Name: HLG-480H-C-SPEC 2019-02-28

SPECIFICATION

MODEL		HLG-480H-C1400□	HLG-480H-C1750□	HLG-480H-C2100□	HLG-480H-C2800□	HLG-480H-C3500□
OUTPUT	RATED CURRENT	1400mA	1750mA	2100mA	2800mA	3500mA
	RATED POWER	480W	480W	481W	479W	480W
	CONSTANT CURRENT REGION Note.2	171 ~ 343V	137~274V	114 ~ 229V	85 ~ 171V	68 ~ 137V
	OPEN CIRCUIT VOLTAGE (max.)	420V	340V	280V	210V	170V
	CURRENT ADJ. RANGE	Adjustable for A/AB-Type only (via built-in potentiometer)				
		700~1400mA	875~1750mA	1050~2100mA	1400~2800mA	1750~3500mA
	CURRENT RIPPLE	5.0% max. @rated current				
	CURRENT TOLERANCE	±5%				
SET UP TIME Note.4	500ms/115VAC,230VAC					
INPUT	VOLTAGE RANGE Note.3	90 ~ 305VAC 127 ~ 431VDC (Please refer to "STATIC CHARACTERISTIC" section)				
	FREQUENCY RANGE	47 ~ 63Hz				
	POWER FACTOR (Typ.)	PF ≥ 0.98/115VAC, PF ≥ 0.97/230VAC, PF ≥ 0.95/277VAC @full load (Please refer to "POWER FACTOR (PF) CHARACTERISTIC" section)				
	TOTAL HARMONIC DISTORTION	THD < 20% (@ load ≥ 40% /115VAC, 230VAC, 277VAC) (Please refer to "TOTAL HARMONIC DISTORTION (THD)" section)				
	EFFICIENCY (Typ.)	95%	95%	95%	95%	95%
	AC CURRENT (Typ.)	5A / 115VAC 2.45A / 230VAC 2A / 277VAC				
	INRUSH CURRENT(Typ.)	COLD START 35A(twidth=1800μs measured at 50% Ipeak) at 230VAC; Per NEMA 410				
	MAX. NO. of PSUs on 16A CIRCUIT BREAKER	2 unit(circuit breaker of type B) / 3 units(circuit breaker of type C) at 230VAC				
	LEAKAGE CURRENT	<0.75mA / 277VAC				
PROTECTION	SHORT CIRCUIT	Constant current, recovers automatically after fault condition is removed				
	OVER VOLTAGE	432 ~ 473V	345 ~ 382V	289 ~ 322V	215 ~ 246V	173 ~ 197V
	OVER TEMPERATURE	Shut down output voltage, re-power on to recovery				
ENVIRONMENT	WORKING TEMP.	Tcase=-40 ~ +90°C (Please refer to "OUTPUT LOAD vs TEMPERATURE" section)				
	MAX. CASE TEMP.	Tcase=+90°C				
	WORKING HUMIDITY	20 ~ 95% RH non-condensing				
	STORAGE TEMP., HUMIDITY	-40 ~ +80°C, 10 ~ 95% RH non-condensing				
	TEMP. COEFFICIENT	±0.02%/°C (0 ~ 60°C)				
	VIBRATION	10 ~ 500Hz, 5G 12min./1cycle, period for 72min. each along X, Y, Z axes				
SAFETY & EMC	SAFETY STANDARDS	UL8750(type"HL"), CSA C22.2 No. 250.13-12; ENEC EN61347-1, EN61347-2-13 independent, EN62384; GB19510.14,GB19510.1; IP65 or IP67, EAC TP TC 004,AS/NZS IEC 61347 . 2. 13; 2013, AS/NZS 61347 . 1 : 2016 approved				
	WITHSTAND VOLTAGE	I/P-O/P:3.75KVAC I/P-FG:2KVAC O/P-FG:1.5KVAC				
	ISOLATION RESISTANCE	I/P-O/P, I/P-FG, O/P-FG:100M Ohms / 500VDC / 25°C / 70% RH				
	EMC EMISSION	Compliance to EN55032 (CISPR32) Class B, EN55015, EN61000-3-2 Class C (@load ≥ 50%); EN61000-3-3; GB17743, GB17625.1, EAC TP TC 020				
	EMC IMMUNITY	Compliance to EN61000-4-2,3,4,5,6,8,11, EN61547, light industry level (surge immunity Line-Earth 4KV, Line-Line 2KV), EAC TP TC 020				
OTHERS	MTBF	421.1K hrs min. Telcordia SR-332(Bellcore) ; 110.5K hrs min. MIL-HDBK-217F (25°C)				
	DIMENSION	262*125*43.8mm (L*W*H)				
	PACKING	2.8Kg;4pcs/12.2Kg/0.55CUFT				
NOTE	<ol style="list-style-type: none"> 1. All parameters NOT specially mentioned are measured at 230VAC input, rated current and 25°C of ambient temperature. 2. Please refer to "DRIVING METHODS OF LED MODULE". 3. De-rating may be needed under low input voltages. Please refer to "STATIC CHARACTERISTIC" sections for details. 4. Length of set up time is measured at first cold start. Turning ON/OFF the power supply may lead to increase of the set up time. 5. The driver is considered as a component that will be operated in combination with final equipment. Since EMC performance will be affected by the complete installation, the final equipment manufacturers must re-qualify EMC Directive on the complete installation again. 6. To fulfill requirements of the latest ErP regulation for lighting fixtures, this LED driver can only be used behind a switch without permanently connected to the mains. 7. This series meets the typical life expectancy of >62,000 hours of operation when Tcase, particularly (Tc) point (or TMP, per DLC), is about 75°C or less. 8. Please refer to the warranty statement on MEAN WELL's website 9. The ambient temperature derating of 3.5°C/1000m with fanless models and of 5°C/1000m with fan models for operating altitude higher than 2000m(6500ft). 10. For any application note and IP water proof function installation caution, please refer our user manual before using. 					

■ BLOCK DIAGRAM

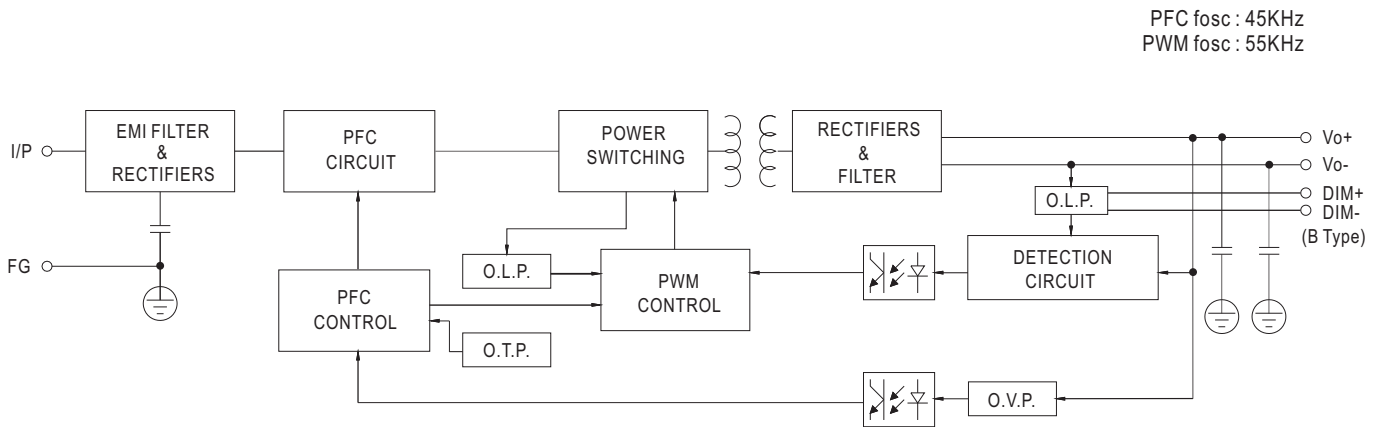

■ DRIVING METHODS OF LED MODULE

※ This series works in constant current mode to directly drive the LEDs.

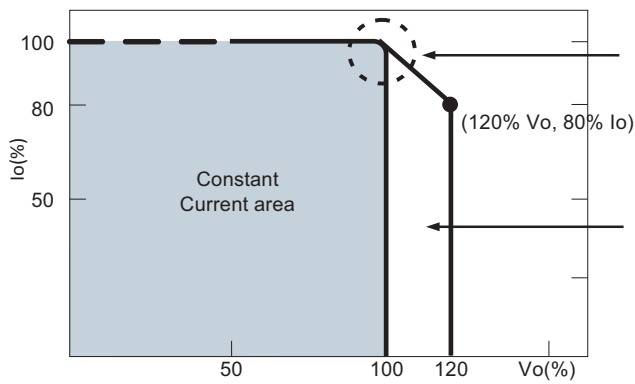

Typical LED driver I-V curve

In the constant current region, the highest voltage at the output of the driver depends on the configuration of the end systems.

Should there be any compatibility issues, please contact TRC Electronics.

MEAN WELL Environment Adaptive Function allows the driver to detect and automatically adjust the output up to 120% V_o with 80% I_o and turns into the desired Constant Current area after the luminaire reaches steady state operation.

Should there be any questions, please contact TRC Electronics.

■ DIMMING OPERATION

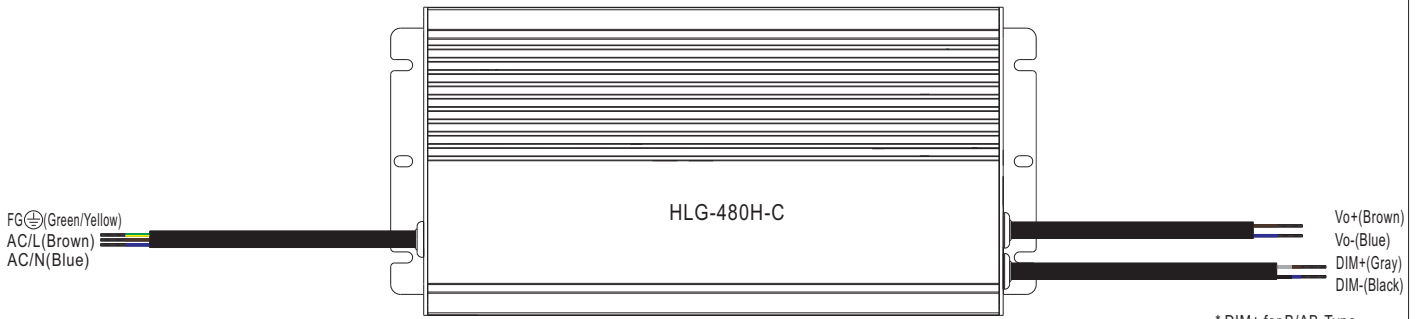

* DIM+ for B/AB-Type
PROG+ for D2-Type
* DIM- for B/AB-Type
PROG- for D2-Type

※ 3 in 1 dimming function (for B/AB-Type)

- Output constant current level can be adjusted by applying one of the three methodologies between DIM+ and DIM-:
0 ~ 10VDC, or 10V PWM signal or resistance.
- Direct connecting to LEDs is suggested. It is not suitable to be used with additional drivers.
- Dimming source current from power supply: 100 μ A (typ.)

◎ Applying additive 0 ~ 10VDC

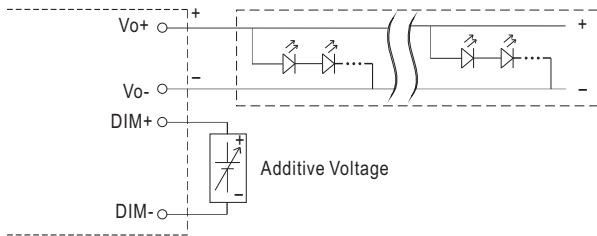

"DO NOT connect "DIM- to Vo-"

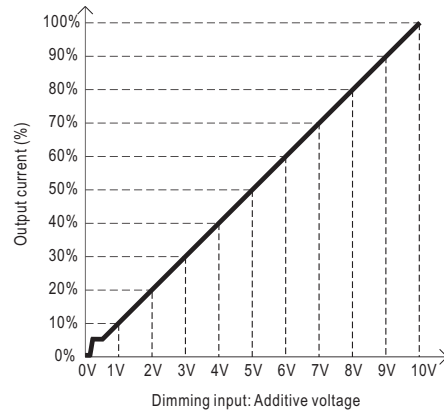

◎ Applying additive 10V PWM signal (frequency range 100Hz ~ 3KHz):

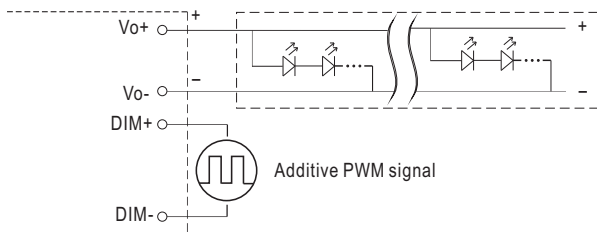

"DO NOT connect "DIM- to Vo-"

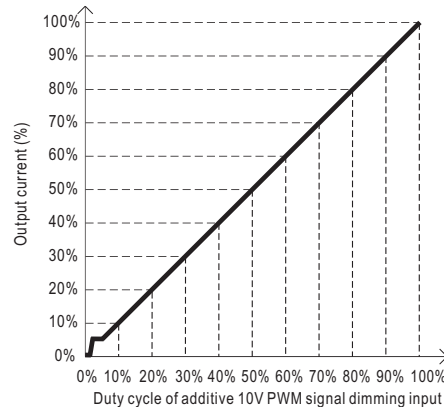

◎ Applying additive resistance:

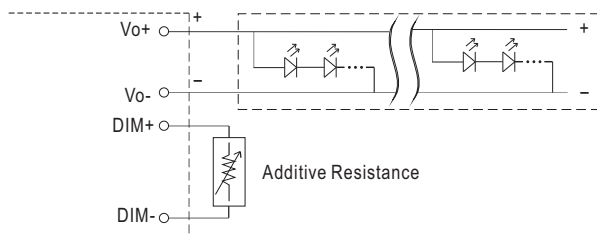

"DO NOT connect "DIM- to Vo-"

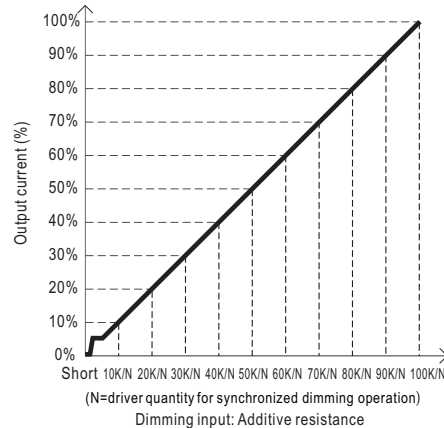

Note : 1. Min. dimming level is about 6% and the output current is not defined when $0\% < I_{out} < 6\%$.
2. The output current could drop down to 0% when dimming input is about $0k\Omega$ or 0Vdc, or 10V PWM signal with 0% duty cycle.

※ **Smart timer dimming function (for Dxx-Type by User definition)**

MEAN WELL Smart timer dimming primarily provides the adaptive proportion dimming profile for the output constant current level to perform up to 14 consecutive hours. 3 dimming profiles hereunder are defined accounting for the most frequently seen applications. If other options may be needed, please contact MEAN WELL for details.

Ex : ☉ D01-Type: the profile recommended for residential lighting

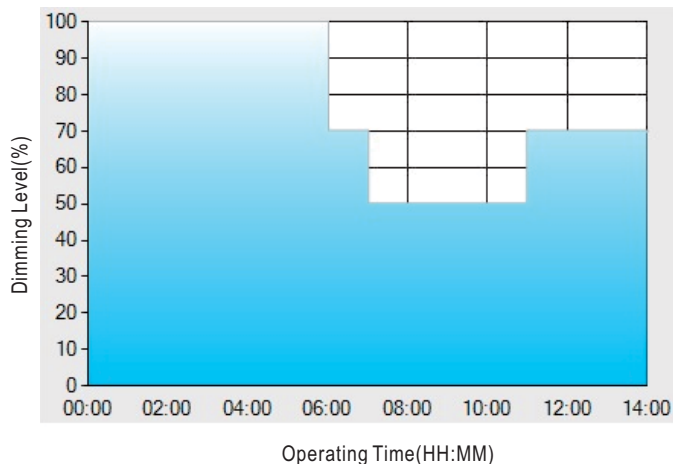

Set up for D01-Type in Smart timer dimming software program:

	T1	T2	T3	T4
TIME**	06:00	07:00	11:00	---
LEVEL**	100%	70%	50%	70%

** : TIME matches Operating Time in the diagram whereas LEVEL matches Dimming Level.

Example: If a residential lighting application adopts D01-Type, when turning on the power supply at 6:00pm, for instance:

- [1] The power supply will switch to the constant current level at 100% starting from 6:00pm.
- [2] The power supply will switch to the constant current level at 70% in turn, starting from 0:00am, which is 06:00 after the power supply turns on.
- [3] The power supply will switch to the constant current level at 50% in turn, starting from 1:00am, which is 07:00 after the power supply turns on.
- [4] The power supply will switch to the constant current level at 70% in turn, starting from 5:00am, which is 11:00 after the power supply turns on.

The constant current level remains till 8:00am, which is 14:00 after the power supply turns on.

Ex : ☉ D02-Type: the profile recommended for street lighting

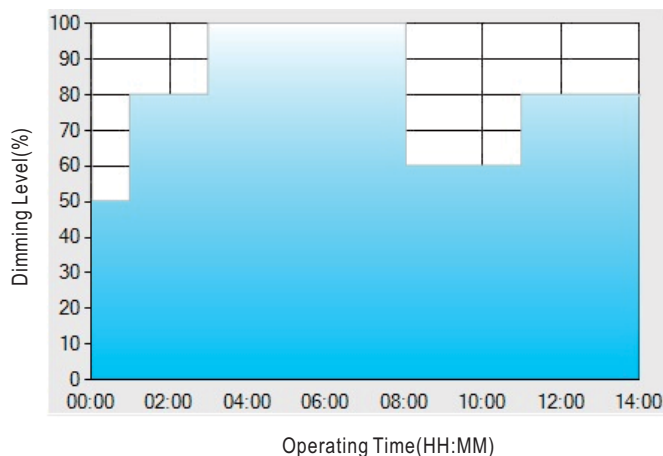

Set up for D02-Type in Smart timer dimming software program:

	T1	T2	T3	T4	T5
TIME**	01:00	03:00	8:00	11:00	---
LEVEL**	50%	80%	100%	60%	80%

** : TIME matches Operating Time in the diagram whereas LEVEL matches Dimming Level.

Example: If a street lighting application adopts D02-Type, when turning on the power supply at 5:00pm, for instance:

- [1] The power supply will switch to the constant current level at 50% starting from 5:00pm.
- [2] The power supply will switch to the constant current level at 80% in turn, starting from 6:00pm, which is 01:00 after the power supply turns on.
- [3] The power supply will switch to the constant current level at 100% in turn, starting from 8:00pm, which is 03:00 after the power supply turns on.
- [4] The power supply will switch to the constant current level at 60% in turn, starting from 1:00am, which is 08:00 after the power supply turns on.
- [5] The power supply will switch to the constant current level at 80% in turn, starting from 4:00am, which is 11:00 after the power supply turns on. The constant current level remains till 6:30am, which is 14:00 after the power supply turns on.

Ex: © D03-Type: the profile recommended for tunnel lighting

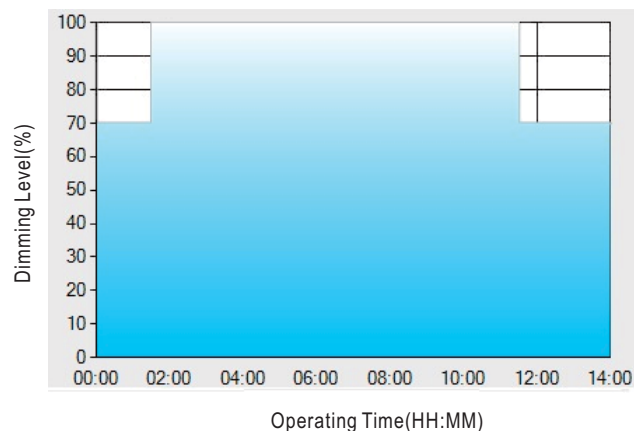

Set up for D03-Type in Smart timer dimming software program:

	T1	T2	T3
TIME**	01:30	11:00	---
LEVEL**	70%	100%	70%

** : TIME matches Operating Time in the diagram whereas LEVEL matches Dimming Level.

Example: If a tunnel lighting application adopts D03-Type, when turning on the power supply at 4:30pm, for instance:

- [1] The power supply will switch to the constant current level at 70% starting from 4:30pm.
 - [2] The power supply will switch to the constant current level at 100% in turn, starting from 6:00pm, which is 01:30 after the power supply turns on.
 - [3] The power supply will switch to the constant current level at 70% in turn, starting from 5:00am, which is 11:00 after the power supply turns on.
- The constant current level remains till 6:30am, which is 14:00 after the power supply turns on.

OUTPUT LOAD vs TEMPERATURE(Note.8)

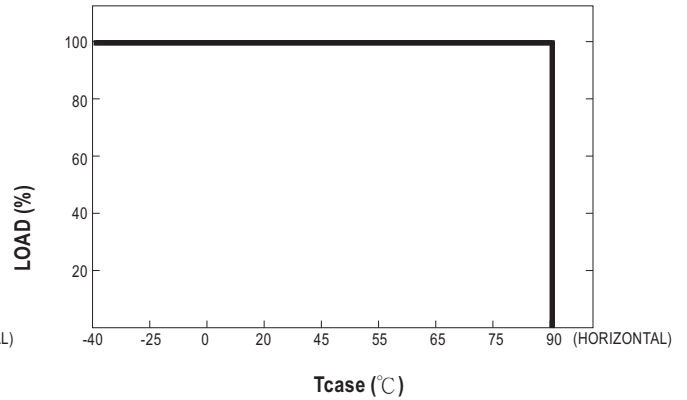
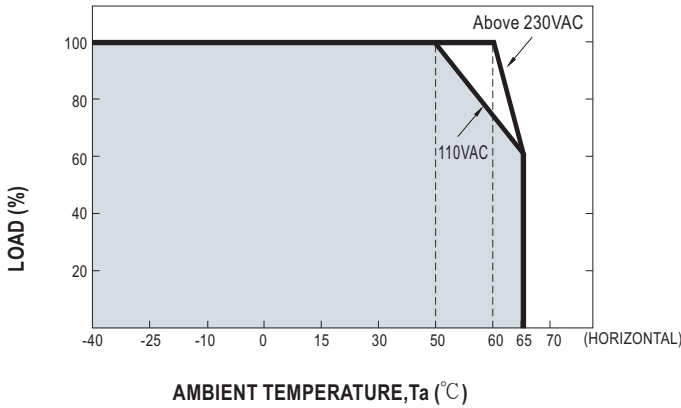

STATIC CHARACTERISTICS

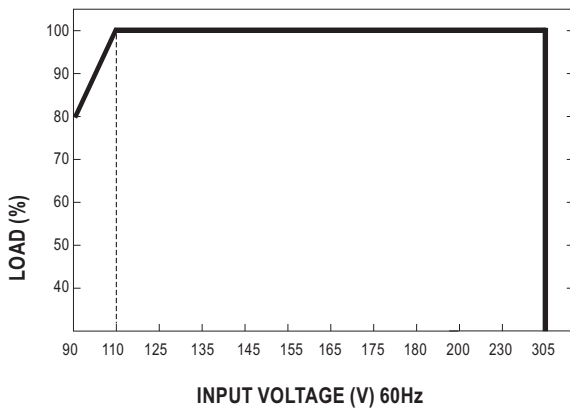

POWER FACTOR(PF) CHARACTERISTIC

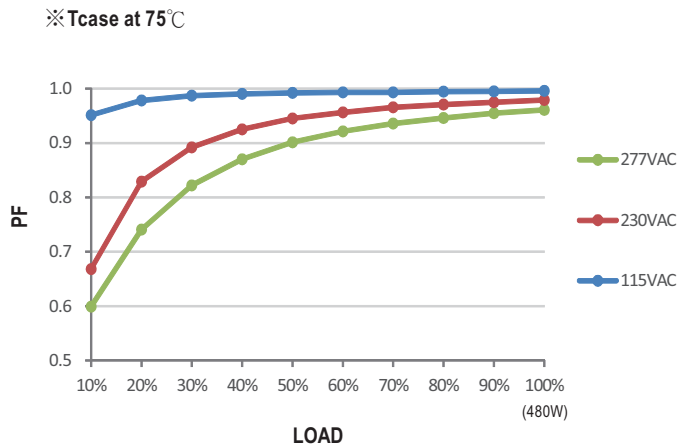

TOTAL HARMONIC DISTORTION (THD)

※ 1400mA Model, Tcase at 75°C

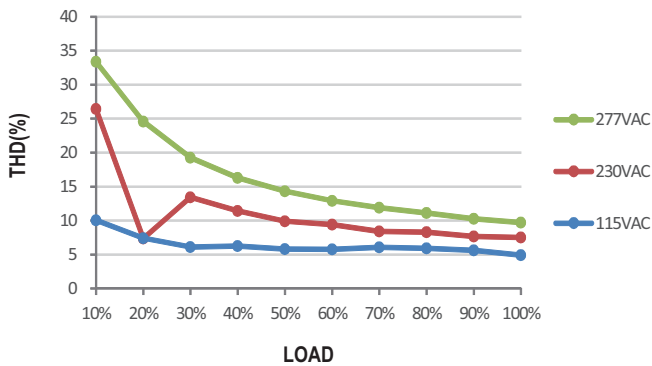

EFFICIENCY vs LOAD

HLG-480H-C series possess superior working efficiency that up to 95% can be reached in field applications.

※ 1400mA Model, Tcase at 75°C

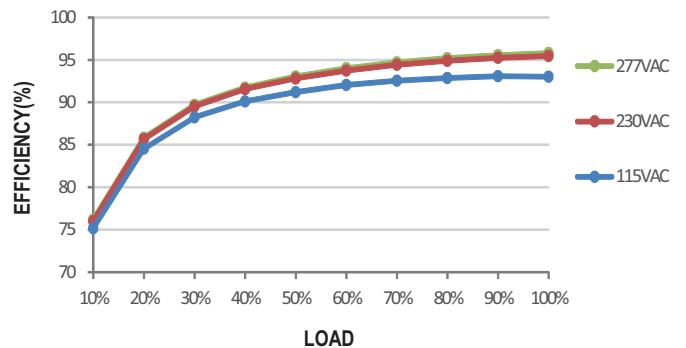

■ LIFE TIME

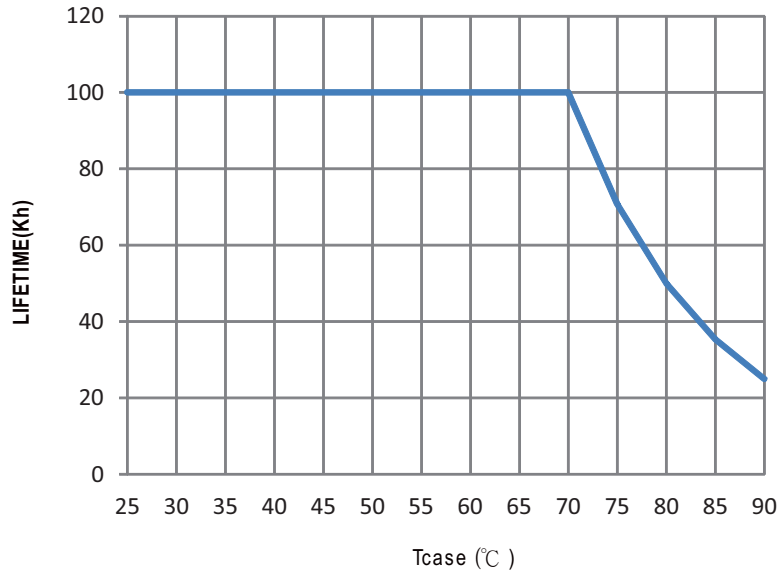

MECHANICAL SPECIFICATION

Case No. 251 Unit:mm

※A-Type

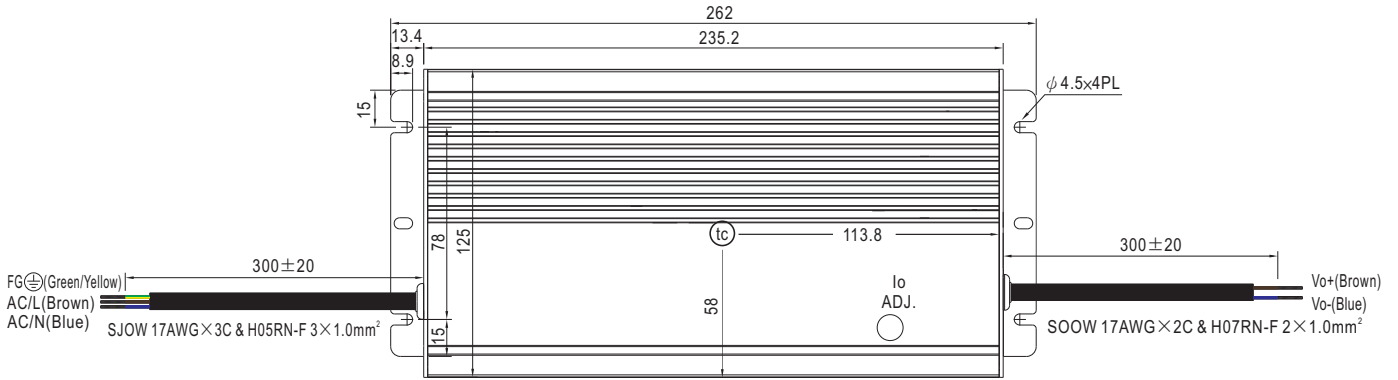

• (tc) : Max. Case Temperature

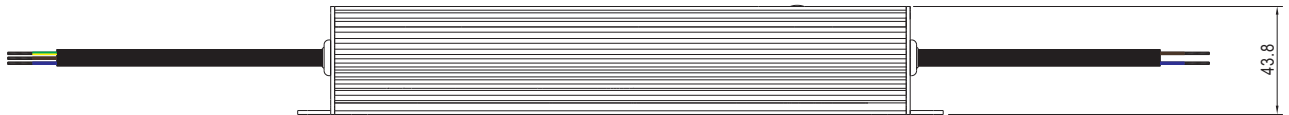

※B/D2-Type

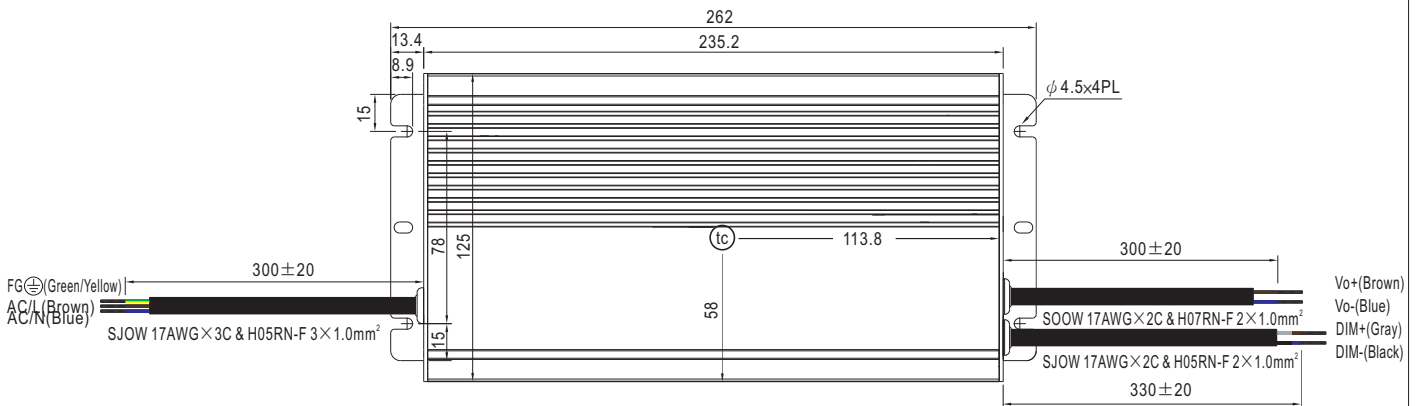

• (tc) : Max. Case Temperature

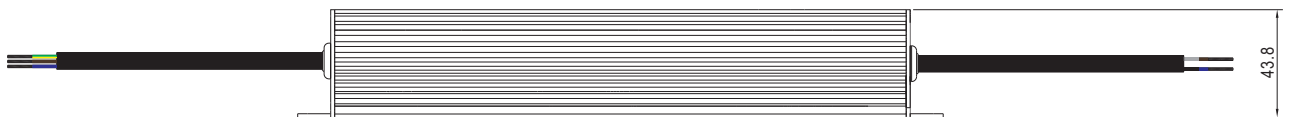

※AB-Type

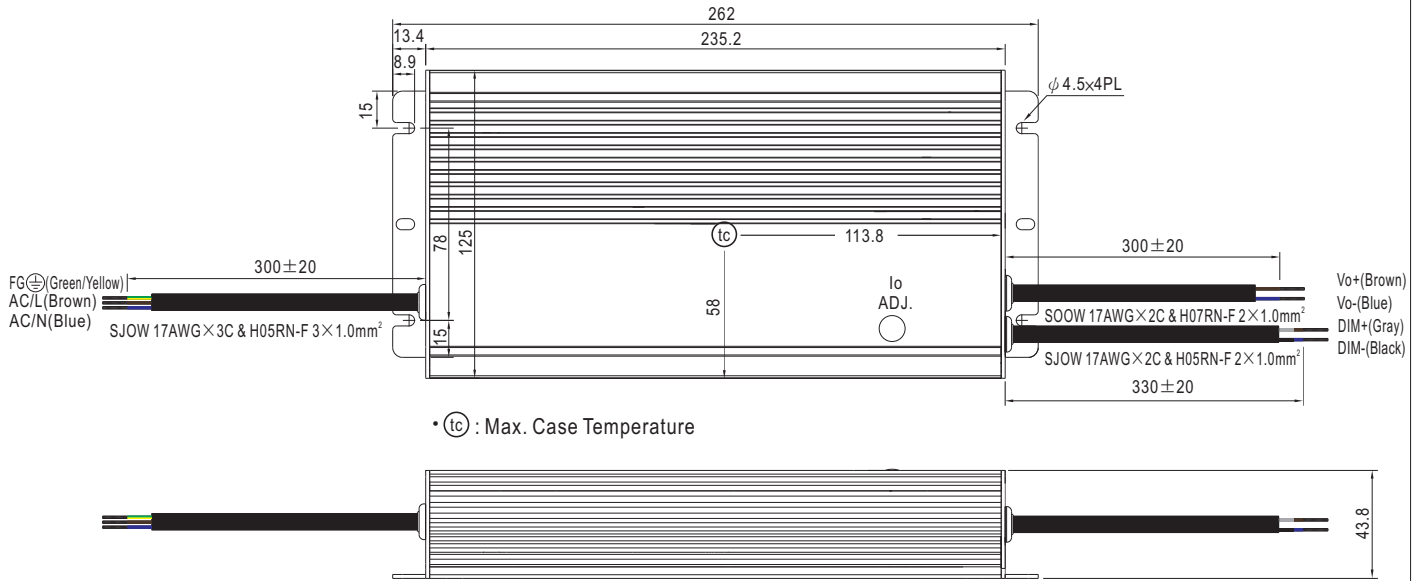

※ Junction Box Option

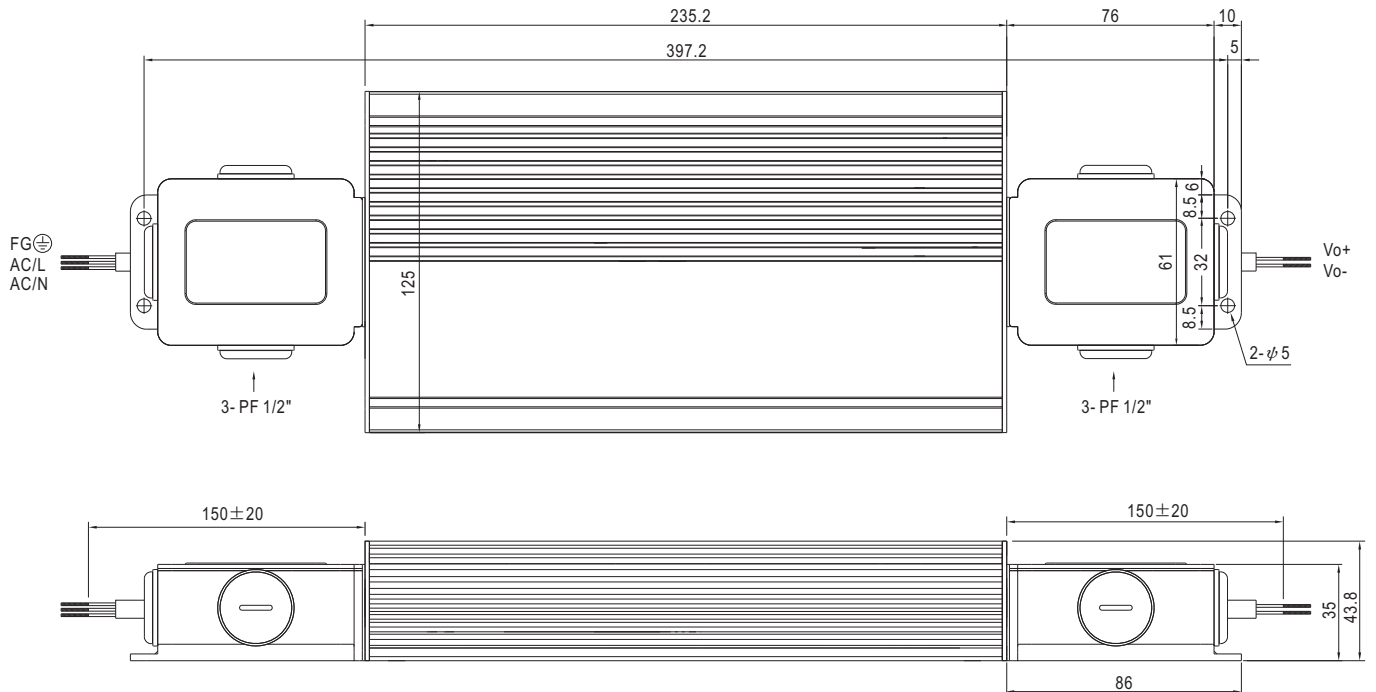

◎ Junction box option is available for all types. Please contact TRC Electronics for details.