



Feature

- Width only 52.5mm (3SU)
- 4:1 ultra wide input range
- -40~+85°C wide working temperature
- No minimum load required
- DC output adjustable ($\pm 10\%$)
- Cooling by free air convection
- Can be installed on DIN rail TS-35/7.5 or 15
- Protections: Short circuit / Overload / Over voltage / Input reverse polarity / Input under voltage protection
- 4KVdc I/O isolation(Reinforced isolation)
- 3 years warranty

Applications

- Industrial control system
- Semi-conductor fabrication equipment
- Factory automation
- Electro-mechanical
- Wireless network
- Telecom or datacom system

Description

DDR-60 series is a 60W DIN Rail type DC-DC converter with main features including DIN rail-type easy installation, ultra slim width (52.5mm), 4:1 ultra wide input voltage, -40~+85°C wide operating temperature, 4KVdc I/O isolation, adjustable output voltage ($\pm 10\%$) and full protective functions...etc.

This series has two input options: 9~36V / 18~75V and various output options: 5V / 12V / 15V / 24V and can be used for industrial control, security control, communication system and other fields. Suitable applications are DC buck/boost regulator, increasing system insulation level and voltage drop compensation along cable...etc.

Model Encoding

DDR - 60 G - 24

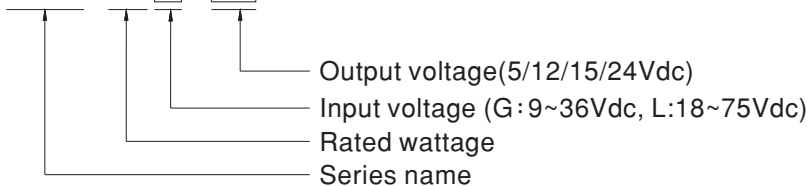

File Name:DDR-60-SPEC 2021-08-30

SPECIFICATION

MODEL		DDR-60G-5	DDR-60G-12	DDR-60G-15	DDR-60G-24	DDR-60L-5	DDR-60L-12	DDR-60L-15	DDR-60L-24	
OUTPUT	DC VOLTAGE	5V	12V	15V	24V	5V	12V	15V	24V	
	RATED CURRENT	10.8A	5A	4A	2.5A	12A	5A	4A	2.5A	
	CURRENT RANGE	0 ~ 10.8A	0 ~ 5A	0 ~ 4A	0 ~ 2.5A	0 ~ 12A	0 ~ 5A	0 ~ 4A	0 ~ 2.5A	
	RATED POWER	54W	60W	60W	60W	60W	60W	60W	60W	
	RIPPLE & NOISE (max.) Note.2	60mVp-p	75mVp-p	75mVp-p	100mVp-p	60mVp-p	75mVp-p	75mVp-p	100mVp-p	
	VOLTAGE ADJ. RANGE	4.5 ~ 5.5V	9 ~ 13.2V	13.5 ~ 16.5V	21.6 ~ 28V	4.5 ~ 5.5V	9 ~ 13.2V	13.5 ~ 16.5V	21.6 ~ 28V	
	VOLTAGE TOLERANCE Note.3	±2.0%	±2.0%	±2.0%	±2.0%	±2.0%	±2.0%	±2.0%	±2.0%	
	LINE REGULATION	±0.5%	±0.5%	±0.5%	±0.5%	±0.5%	±0.5%	±0.5%	±0.5%	
	LOAD REGULATION	±1.5%	±0.5%	±0.5%	±0.5%	±1.5%	±0.5%	±0.5%	±0.5%	
	SETUP, RISE TIME	120ms, 85ms at full load								
	HOLD UP TIME (Typ.)	G-type: 5ms@24Vdc input					L-type: 10ms@48Vdc input			
EXTERNAL CAPACITANCE LOAD (Max.)	6800 μF	4700 μF	3300 μF	2200 μF	6800 μF	4700 μF	3300 μF	2200 μF		
INPUT	VOLTAGE RANGE Note.4	9 ~ 36Vdc				18 ~ 75Vdc				
	EFFICIENCY (Typ.)	87.5%	91%	91%	91%	87.5%	91%	92%	92%	
	DC CURRENT (Typ.)	3A/24Vdc				1.5A/48Vdc				
	INRUSH CURRENT (Typ.)	20A/24Vdc				20A/48Vdc				
PROTECTION	OVERLOAD	105 ~ 135% rated output power Protection type : Constant current limiting, recovers automatically after fault condition is removed								
	OVER VOLTAGE	5.75 ~ 7V	13.8 ~ 16.2V	17.25 ~ 20.25V	28.8 ~ 34V	5.75 ~ 7V	13.8 ~ 16.2V	17.25 ~ 20.25V	28.8 ~ 34V	
	REVERSE POLARITY	By internal MOSFET, no damage, recovers automatically after fault condition removed								
	UNDER VOLTAGE LOCKOUT	24Vin (G-type):Power ON ≥ 9V , OFF ≤ 8.5V 48Vin (L-type):Power ON ≥ 18V , OFF ≤ 17V								
	WORKING TEMP.	-40 ~ +85°C (Refer to "Derating Curve")								
ENVIRONMENT	WORKING HUMIDITY	5 ~ 95% RH non-condensing								
	STORAGE TEMP., HUMIDITY	-40 ~ +85°C , 5 ~ 95% RH non-condensing								
	TEMP. COEFFICIENT	±0.03%/°C (0 ~ 60°C)								
	VIBRATION	Component:10 ~ 500Hz, 2G 10min./1cycle, 60min. each along X, Y, Z axes; Mounting: Compliance to IEC60068-2-6								
	OPERATING ALTITUDE	5000 meters								
	SAFETY STANDARDS	IEC 62368-1, UL 62368-1, AS/NZS 62368-1, EAC TP TC 004 approved								
SAFETY & EMC (Note 5)	WITHSTAND VOLTAGE	I/P-O/P:4KVdc								
	ISOLATION RESISTANCE	I/P-O/P>100M Ohms / 500Vdc / 25°C / 70% RH								
	EMC EMISSION	Parameter	Standard			Test Level / Note				
		Conducted	BS EN/EN55032			Class A				
		Radiated	BS EN/EN55032			Class A for 1m I/O cable , Class B for 30cm I/O cable				
		Voltage Flicker	BS EN/EN61000-3-3			----				
	EMC IMMUNITY	BS EN/EN55024 , BS EN/EN61000-6-2(BS EN/EN50082-2)								
		Parameter	Standard			Test Level / Note				
		ESD	BS EN/EN61000-4-2			Level 3, 8KV air ; Level 3, 6KV contact; criteria A				
		Radiated	BS EN/EN61000-4-3			Level 3, 10V/m ; criteria A				
		EFT / Burst	BS EN/EN61000-4-4			Level 3, 2KV ; criteria A				
Surge		BS EN/EN61000-4-5			Level 3, 1KV/Line-Line ; criteria A					
Conducted		BS EN/EN61000-4-6			Level 3, 10V ; criteria A					
Magnetic Field	BS EN/EN61000-4-8			Level 4, 30A/m ; criteria A						
OTHERS	MTBF	611K hrs min. MIL-HDBK-217F (25°C)								
	DIMENSION	52.5*90*54.5mm (W*H*D)								
	PACKING	216g; 60pcs/14Kg/0.97CUFT								
NOTE	1. All parameters NOT specially mentioned are measured at normal input (G:24Vdc, L:48Vdc), rated load and 25°C of ambient temperature. 2. Ripple & noise are measured at 20MHz of bandwidth by using a 12" twisted pair-wire terminated with a 0.1 μf & 47 μf parallel capacitor. 3. Tolerance : includes set up tolerance, line regulation and load regulation. 4. Derating may be needed under low input voltage. Please check the derating curve for more details. 5.The power supply is considered as an independent unit, but the final equipment still need to re-confirm that the whole system complies with the EMC directives. For guidance on how to perform these EMC tests, please refer to "EMI testing of component power supplies." (as available on http://www.meanwell.com) 6. The ambient temperature derating of 3.5°C/1000m with fanless models and of 5°C/1000m with fan models for operating altitude higher than 2000m(6500ft). ※ Product Liability Disclaimer : For detailed information, please refer to https://www.meanwell.com/serviceDisclaimer.aspx									

■ Block Diagram

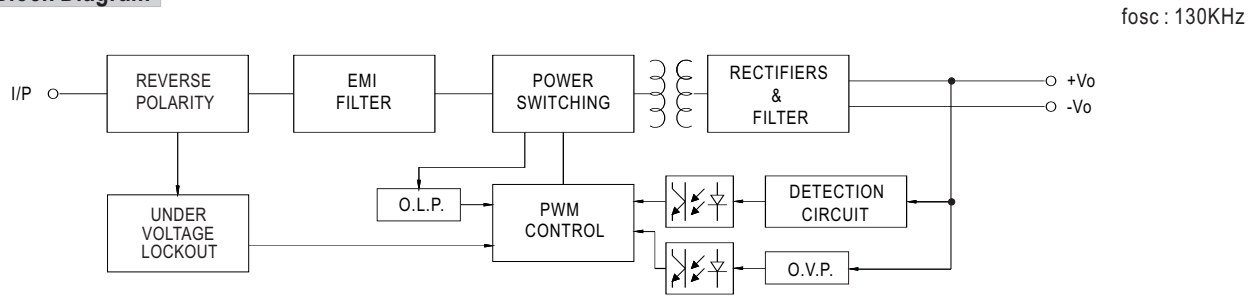

■ Derating Curve

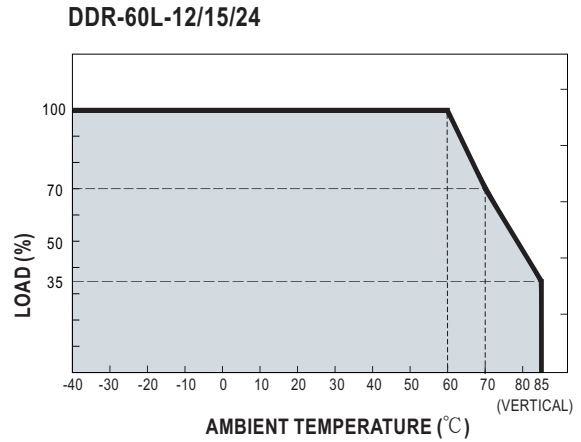
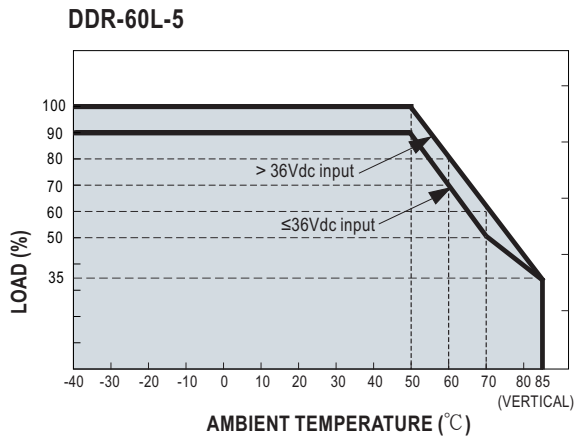
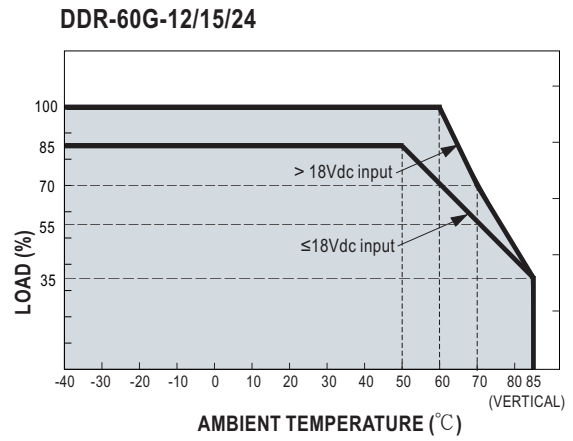
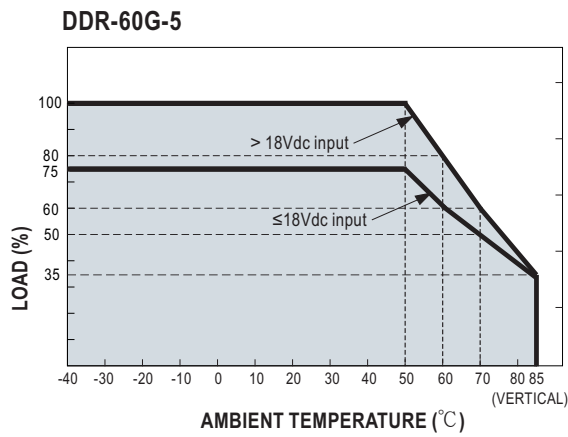

■ Output derating VS input voltage

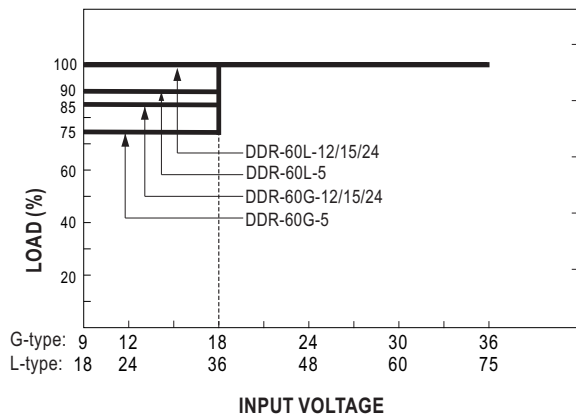

■ Mechanical Specification

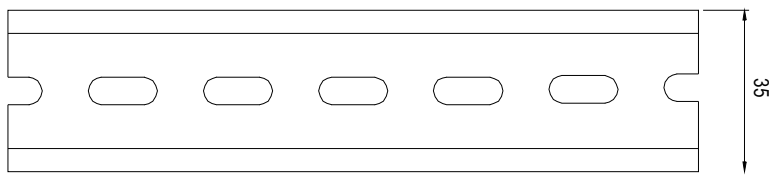
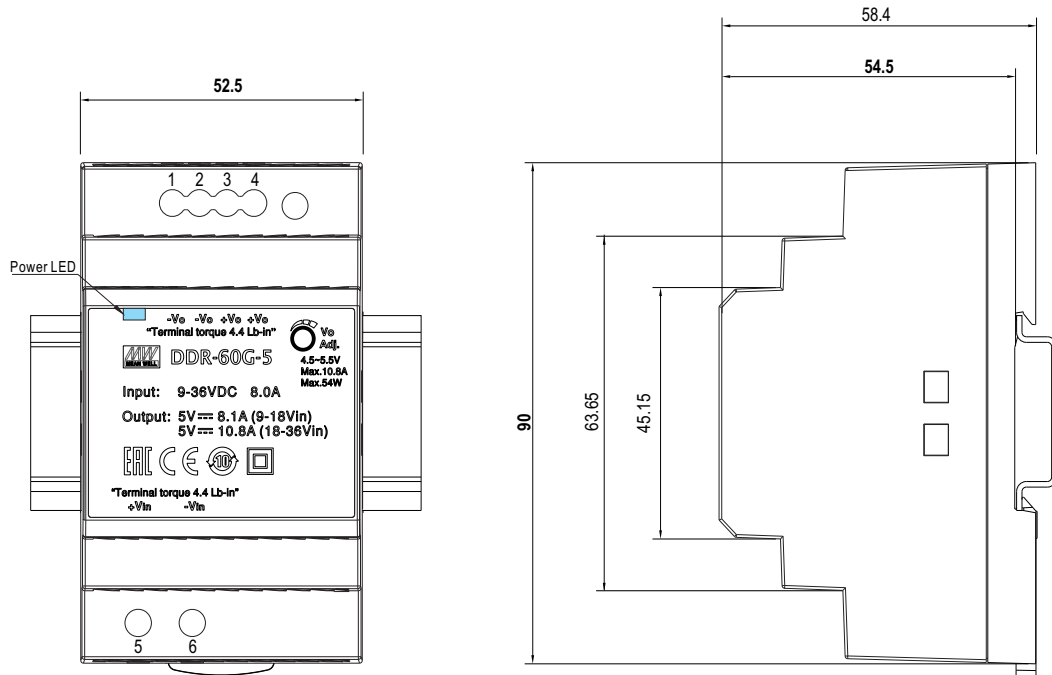

ADMISSIBLE DIN-RAIL: TS35/7.5 OR TS35/15

Pin No.	Assignment
1,2	DC output $-V_o$
3,4	DC output $+V_o$
5	DC input $+V_{in}$
6	DC input $-V_{in}$