

# 040APS15 BA

## Highlights & Features

- Safety Approvals to IEC 60601-1 3.1rd ed. & IEC 62368-1
- Compliant with IEC 60601-1-2 4th Ed. Requirements
- Low touch current (<0.1 mA Normal & <0.3 mA single fault)
- Over-Voltage/Load/Temperature & Short Circuit protections
- 3 Million Hours MTBF
- 2 x MOPP (means of patient protection)
- 3 years warranty

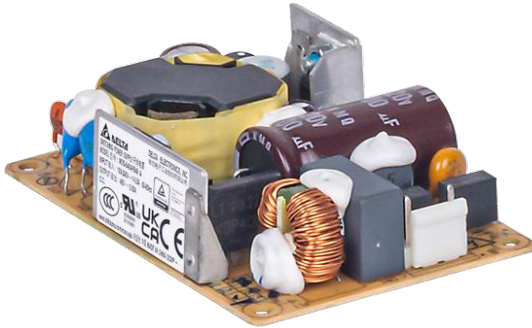

## Safety Standards



CB Certified for worldwide use

**Model Number:** MDS-040APS15 BA  
**Unit Weight:** 80 grams (2.88 ounces)  
**Dimensions (W x L x H):** 50.8 x 76.2 x 23 mm  
 (2 x 3 x 0.91 inch)

## General Description

The MDS series of embedded power supply come with universal AC input at 90 Vac to 264 Vac. Other features include low touch current, risk management report available and the electric shock protection comply with 2 x MOPP. The MDS series is certified for EMC standards according to EN/BS EN 55011 for industrial, scientific and medical (ISM) radio-frequency equipment and EN/BS EN 55032 for Industrial Technology Equipment (ITE) radio-frequency equipment.

The MDS series of embedded power supply come with both medical and ITE safety approvals including UL/cUL/CE and CB certification and are fully compliant with RoHS Directive for environmental protection.

## Model Information

Medical AC-DC Open Frame

Model Number	Input Voltage Range	Output Voltage	Output Current
MDS-040APS15 BA	90-264 Vac	15 Vdc	2.67 A

## Model Numbering

<b>MDS</b>	-	<b>040</b>	<b>APS</b>	<b>15</b>	<b>BA</b>
Medical Power Supply		Max wattage in the product series. Maybe lower at some voltage. 040 → 40 W	Family Code	Output Voltage Single Output: 15 for 15 V	Delta STD

## Specifications

### Input Ratings / Characteristics

Nominal Input Voltage	100-240 Vac
Input Voltage Range	90-264 Vac
Nominal Input Frequency	50-60 Hz
Input Frequency Range	47-63 Hz
Input Current (max.)	0.85 A @ 115 Vac, 0.45 A @ 230 Vac
Efficiency (typ.)	87.2%, Reference Fig. 1
Standby Power (max.)	0.3 W
Inrush Current (typ.)	30 A @ 115 Vac, 60 A @ 230 Vac
Touch Current (max.)	0.1 mA @ 264 Vac NC <sup>1)</sup> , 0.3 mA @ 264 Vac SFC <sup>2)</sup>

1) NC: normal condition

2) SFC: single fault condition

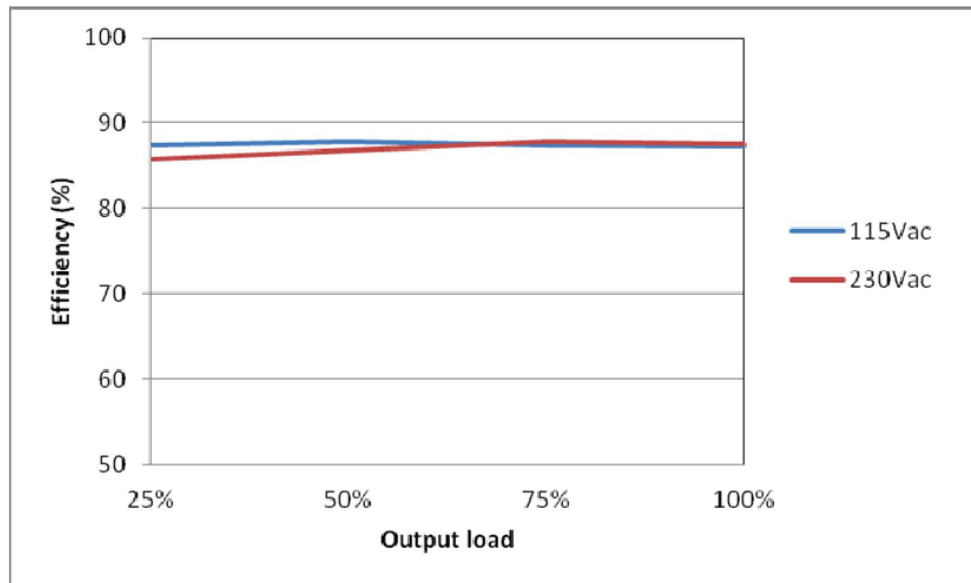

Fig. 1 Efficiency versus output load

### Output Ratings / Characteristics

Nominal Output Voltage	15 Vdc
Total regulation	± 1.5%
Output Current	2.67 A
Output Power	40 W
Line Regulation (max)	± 0.5%
Load Regulation (max)	± 1%
Ripple & Noise (typ.)	16.4 mV pk-pk @ Full load, Reference Fig. 2
Start-up Time (max)	3000 ms @ 115 Vac
Hold-up Time (min)	15 ms @ 115 Vac
Dynamic Response (Overshoot & Undershoot O/P Voltage)	± 3% @ 50-100% load

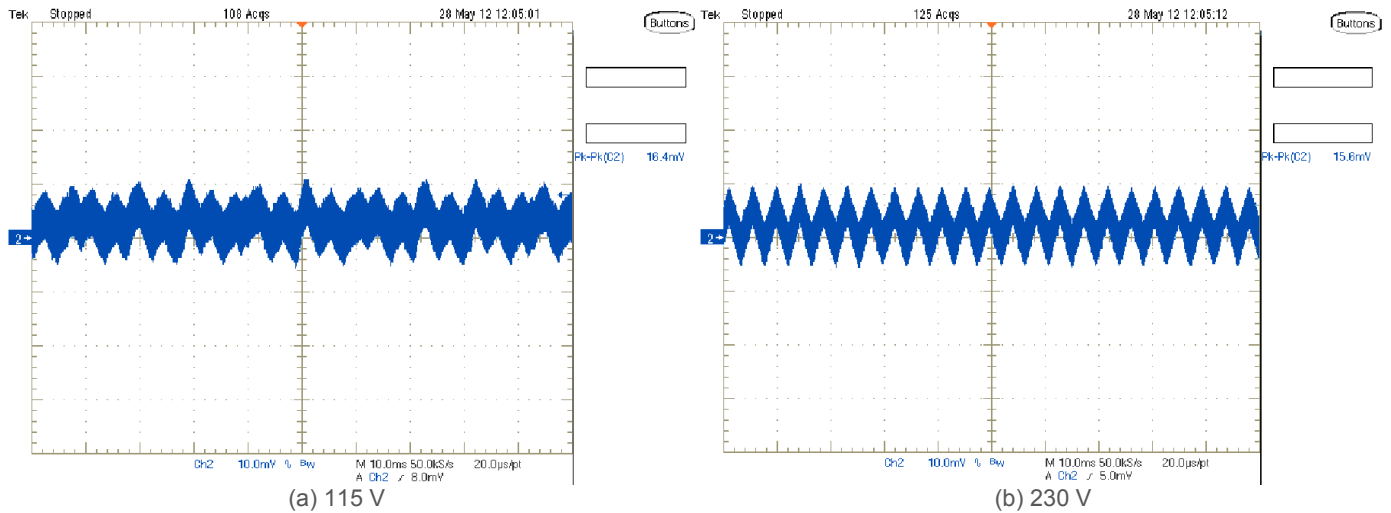
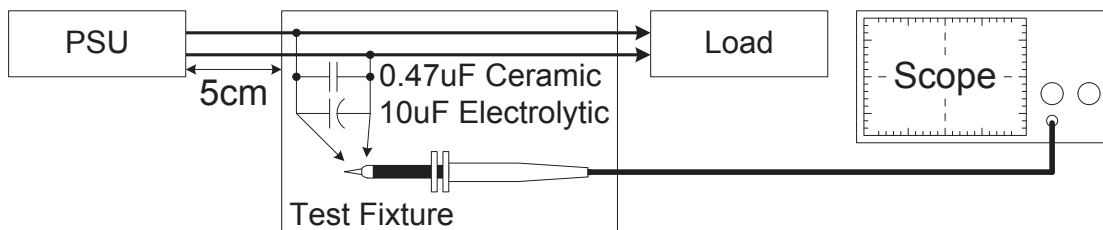

Fig. 2 Ripple & Noise example, 20 MHz BW

Ripple & Noise measurement circuit



**Mechanical**

Dimensions (W x L x H)	50.8 x 76.2 x 23 mm (2 x 3 x 0.91 inch)	
Weight (typ.)	80 grams (2.88 ounces)	
Terminal	Input	JST 2P Connector: B2P3-VH(LF)(SN)
	Output	JST 4P Connector: B4P-VH(LF)(SN)

**Environment**

Surrounding Air Temperature	Operating	-10°C to +70°C
	Storage	-40°C to +85°C
Power De-rating	-10°C to +50°C 100% load 50°C to 70°C de-rate power by 2.5% / °C, See Fig. 3	
Operating Humidity	10-95% RH (Non-Condensing)	
Operating Altitude	3,000 meters (9842.52 feet)	
Shock Test (Non-Operating)	50 G, 11ms, 3 shocks for each direction	
Vibration (Non-Operating)	5-500 Hz, 2.09 Grms, 20 minute for each three axis	

### Protections

Overvoltage (max)	150%, Latch Mode
Over load / Over current (max)	150%~210% of rated load current, Hiccup Mode, (Non-Latching, Auto-Recovery)
Over Temperature	Hiccup Mode, (Non-Latching, Auto-Recovery)
Short Circuit	Hiccup Mode, (Non-Latching, Auto-Recovery)
Protection Against Shock	Class I with PE* connection

\*PE: Protective Earth

### Reliability Data

MTBF (typ.)	3 Million Hours based on Telecordia SR-332
-------------	--

### Safety Standards / Directives

Medical Safety	IEC 60601-1 3 <sup>rd</sup> and 3.1 <sup>st</sup> edition CB report IEC 60601-1 edition 3.1 <sup>st</sup> (2012), EN 60601-1 (2006) + A11 + A1 + A12, CAN/CSA-C22.2 NO. 60601-1:14, ANSI/AAMI ES60601-1:2005/(R)2012	
ITE Safety	IEC 60950-1 (Ed.2,2005), IEC 62368-1, CCC GB 17625.1; GB 4943.1; GB/T 9254.1	
CE	In conformance with EMC Directive 2014/30/EU and Low Voltage Directive 2014/35/EU EN 60601-1: 2006 + A11: 2011 + A1: 2013 + A12: 2014 & EN 60601-1-2: 2015	
UKCA	In conformance with Electrical Equipment (Safety) Regulations 2016 and Electromagnetic Compatibility Regulations 2016, Medical Devices Regulations 2002(UK MDR 2002)	
Galvanic Isolation	Input to Output	4000 Vac
	Input to Ground	1500 Vac
	Output to Ground	500 Vac

EMC (Compliant with IEC 60601-1-2 4th Ed. Requirements)

EMC / Emissions		EN/BS EN 55011, EN/BS EN 55032, FCC Title 47: Class B
Harmonic Current Emissions	IEC61000-3-2	
Voltage Flicker	IEC61000-3-3	
Immunity to		
Electrostatic Discharge	IEC61000-4-2	Level 4 Criteria A <sup>1)</sup> Air Discharge: 15 kV Contact Discharge: 8 kV
Radiated Field	IEC61000-4-3	Criteria A <sup>1)</sup> 80 MHz-2700 MHz, 10 V/m AM modulation 385 MHz-5785 MHz, 28 V/m Pulse mode and other modulation
Electrical Fast Transient / Burst	IEC61000-4-4	Level 3 Criteria A <sup>1)</sup> : 2 kV
Surge	IEC61000-4-5	Level 3 Criteria A <sup>1)</sup> Common Mode <sup>3)</sup> : 2 kV Differential Mode <sup>4)</sup> : 1 kV
Conducted	IEC61000-4-6	Level 2 Criteria A <sup>1)</sup> 150 kHz-80 MHz, 3 Vrms, 6 Vrms at ISM bands and Amateur radio bands
Power Frequency Magnetic Fields	IEC61000-4-8	Criteria A <sup>1)</sup> Magnetic field strength 30 A/m
Voltage Dips	IEC61000-4-11	Criteria A <sup>1)</sup> 0% U <sub>T</sub> , 0.5 cycle (10 ms) 0°/45°/90°/135°/180°/225°/270°/315°/360°  Criteria B <sup>2)</sup> 0% U <sub>T</sub> , 1 cycle (20 ms), 0°  Criteria A <sup>1)</sup> 70% U <sub>T</sub> , 25 cycle (500 ms), 0°  Criteria B <sup>2)</sup> 0% U <sub>T</sub> , 250 cycle (5000 ms), 0°

1) Criteria A: Normal performance within the specification limits  
2) Criteria B: Output out of regulation, or shuts down during test. Automatically restore to normal operation after test.  
3) Asymmetrical: Common mode (Line to earth)  
4) Symmetrical: Differential mode (Line to line)

**Block Diagram**

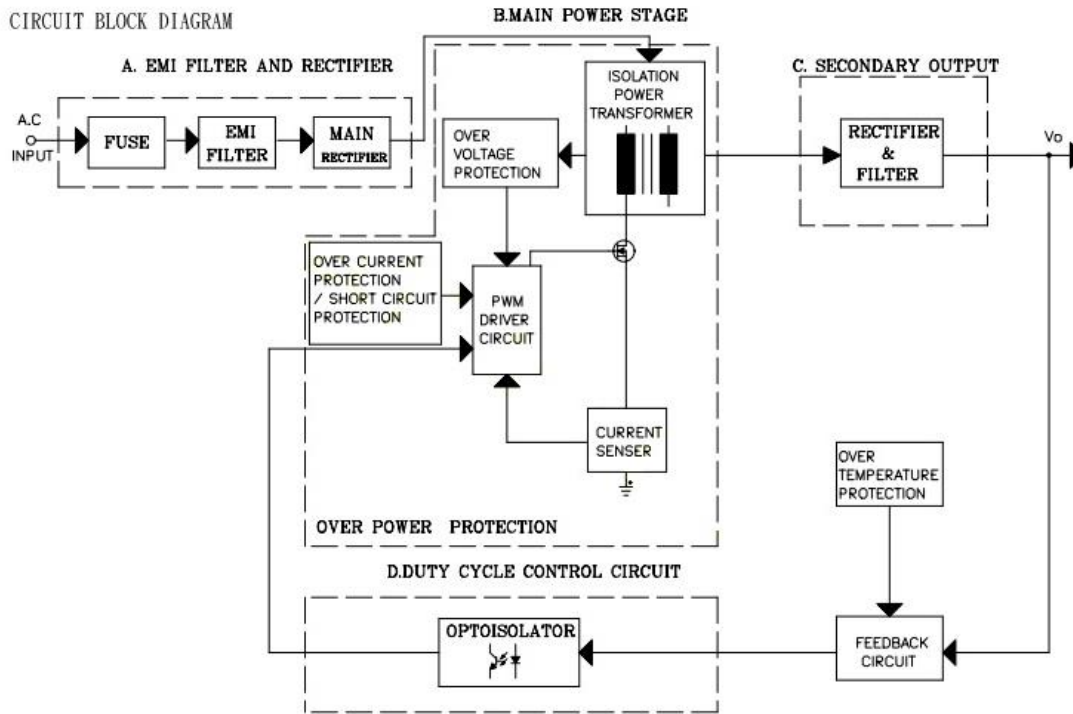

### Dimensions

W x L x H: 50.8 x 76.2 x 23 mm (2 x 3 x 0.91 inch)

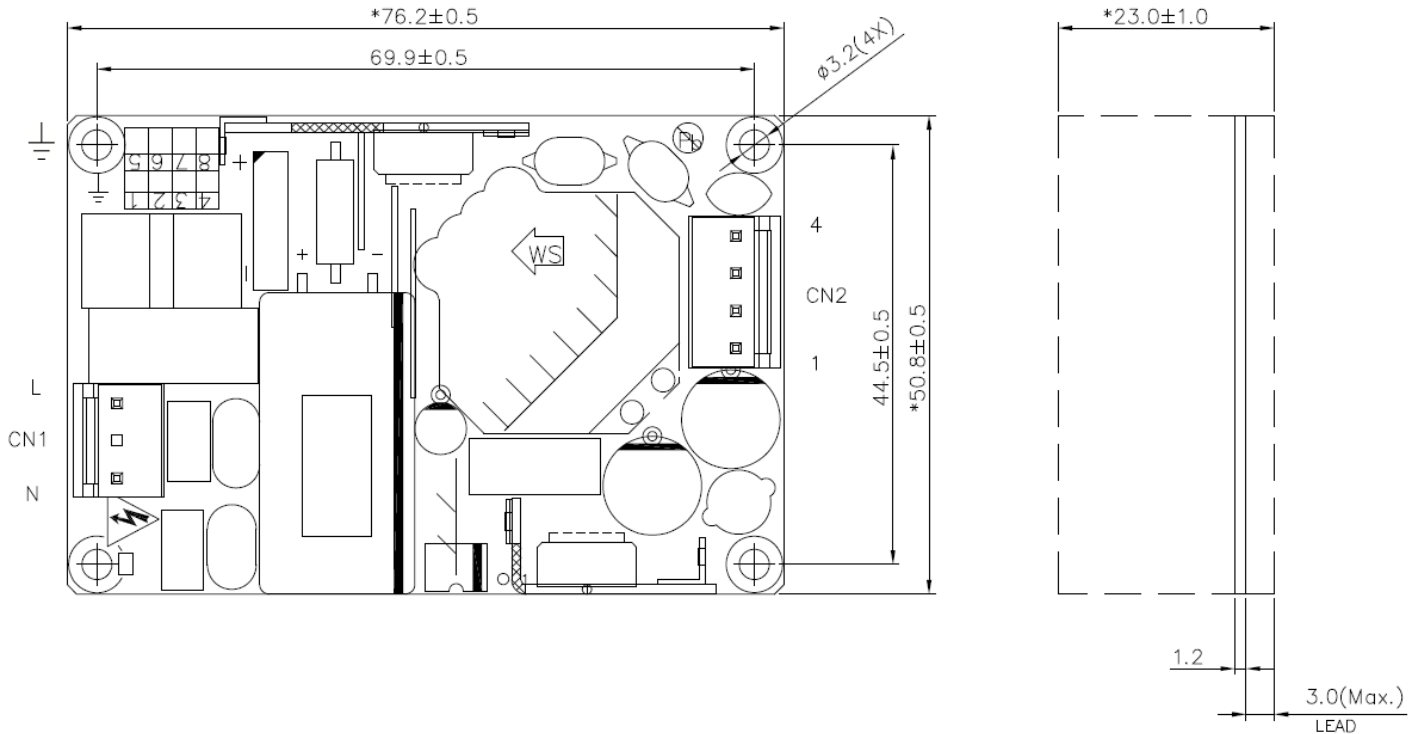

PIN ASSIGNMENT TABLE

ITEM	PIN NO.	FUNCTION	CONNECTOR
CN1 (AC)	1	L	JST: B2P3-VH(LF)(SN) MATING WITH JST: VHR-3N (middle terminal should be blank)
	3	N	
CN2 (DC)	1	+V	JST: B4P-VH(LF)(SN) MATING WITH JST: VHR-4N
	2		
	3	GND	
	4		

### Notes

- Dimensions are in mm
- For optimum EMC performance, all mounting points shown in mechanical drawing need to be connected together to system earth case.
- Method of protective earth connection:  
 All mounting holes are needed to link system together by conductive screw then connected together to system earth case.

### Power De-rating

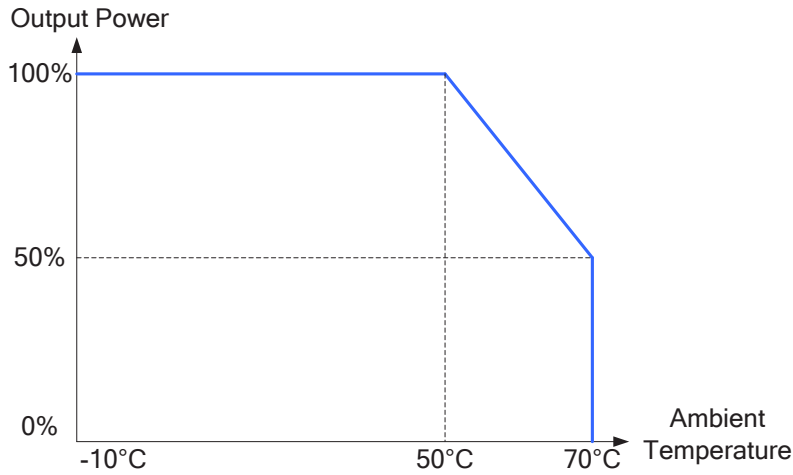

Fig. 3

### Functions

#### Start-up Time

The time required for the output voltage ( $V_o$ ) to reach 90% of its set value, after the input AC voltage is applied.

#### Rise Time

The time required for the output voltage ( $V_o$ ) to change from 10% to 90% of its steady state value.

#### Hold-up Time

Hold up time is the time when the AC input collapses and output voltage retains regulation for a certain period of time. The time required for the output to reach 95% of its set value, after the input voltage is removed.

#### ■ Graph illustrating the Start-up Time, Rise Time, and Hold-up Time

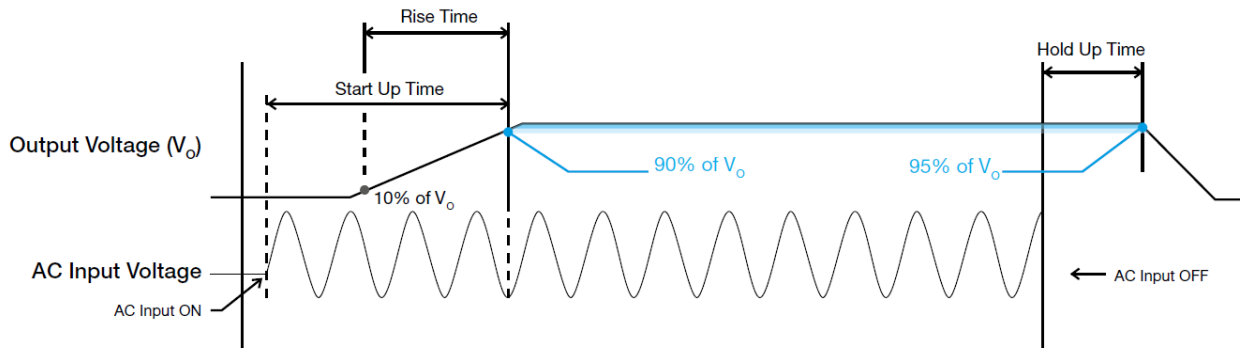



### Dynamic Response

The power supply output voltage will remain within  $\pm 3\%$  of its steady state value, when subjected to a dynamic load change from 50 to 100% of its rated current.

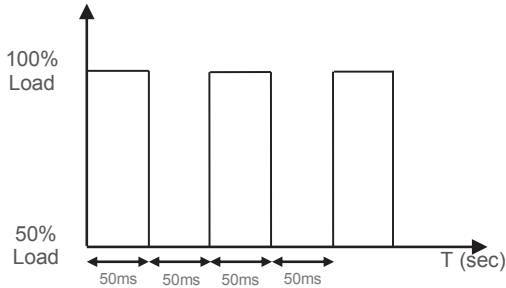

### Inrush Current

Inrush current is the input current that occurs when the input voltage is first applied. For AC input voltages, the maximum peak value of inrush current will occur during the first half cycle of the applied AC voltage. This peak value decreases exponentially during subsequent cycles of AC voltage.

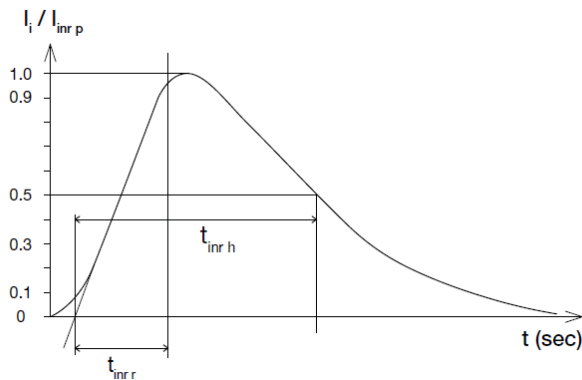

### Overvoltage Protection

The power supply's overvoltage circuit will be activated when its internal feedback circuit fails. The output voltage shall not exceed its specifications defined on Page 4 under "Protections". Power supply will latch off, and require removal/re-application of input AC voltage in order to restart.

### Short Circuit Protection

The power supply's output OLP/OCP function also provides protection against short circuits. When a short circuit is applied, the output current will operate in "Hiccup mode", as shown in the illustration in the OLP/OCP section on this page. The power supply will return to normal operation after the short circuit is removed.

### Overload & Over current Protections

The power supply's Overload (OLP) and Over current (OCP) Protections will be activated when output current is between 150% and 210% of  $I_o$  (Max load). Upon such an occurrence,  $V_o$  will start to drop. Once the power supply has reached its maximum power limit, the protection will be activated, and the power supply will go into "Hiccup mode" (Auto-Recovery). The power supply will recover once the fault condition causing the OLP and OCP is removed and  $I_o$  is back within the specified limit.

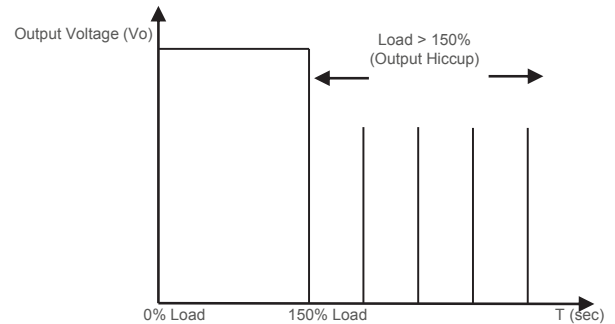

Additionally, if the  $I_o$  is  $< 210\%$  but  $> 150\%$  for a prolonged period of time (depending on the load), the Over Temperature Protection (OTP) will be activated due to high temperature on critical components. The power supply will then go into hiccup mode until the fault is removed; and, the input voltage is removed, then reapplied.

### Over Temperature Protection

As mentioned above, the power supply also has Over Temperature Protection (OTP). This is activated when the overload condition persists for an extended duration and the output current is below the overload trigger point but  $> 100\%$  load. In the event of a higher operating condition at 100% load, the power supply will run into OTP when the surrounding air temperature is higher than the operating temperature. When activated, the output voltage will go into hiccup mode until the input voltage is removed; then, reapplied, and the surrounding air temperature drops to its normal operating temperature.

**Certificate**



Delta has been certified as meeting the requirement of ISO 13485: 2003 and EN ISO 13485:2012 for the design and manufacture of switching power supply and adaptor for medical device.



In addition to a UL Total Certification Program (TCP) approved client laboratory for IEC62368-1. Delta also has participated UL Client Test Data Program (CDTP) for IEC 60601

(September 2023, Rev. 13)