



## ■ Features

- Constant Current mode output with multiple levels selectable by dip switch
- Plastic housing with class II design
- Built-in active PFC function
- Functions: 3 in 1 dimming (dim-to-off); Auxiliary DC output; synchronization up to 10 units
- 3 years warranty

## ■ Applications

- LED indoor lighting
- LED office lighting
- LED architectural lighting
- LED panel lighting

## ■ Description

LCM-40U series is a 35W LED AC/DC constant current mode output LED driver featuring the multiple levels selectable by dip switch. LCM-40U operates from 90~132VAC and offers different current levels ranging between 350mA and 1050mA. Thanks to the efficiency up to 87.5%, with the fanless design, the entire series is able to operate for -30°C~+90°C case temperature under free air convection. LCM-40U is equipped with various functions, such as the dimming function and synchronization, so as to provide the optimal design flexibility for LED lighting system.

## ■ Model Encoding

**LCM - 40U**

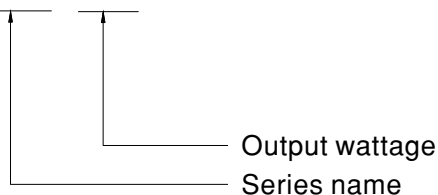

**SPECIFICATION**

MODEL		LCM-40U					
OUTPUT	CURRENT LEVEL	Current level selectable via DIP switch, please refer to "DIP SWITCH TABLE" section					
		350mA	500mA	600mA	700mA(default)	900mA	1050mA
	RATED POWER	35W					
	DC VOLTAGE RANGE	2 ~ 100V	2 ~ 70V	2 ~ 59V	2 ~ 50V	2 ~ 39V	2 ~ 34V
	OPEN CIRCUIT VOLTAGE (max.)	110V			65V		
	CURRENT RIPPLE <small>Note.6</small>	5.0% max. @rated current					
	CURRENT TOLERANCE	±5%					
	AUXILIARY DC OUTPUT	Nominal 12V(deviation 11.4~12.6V)@50mA					
SETUP TIME <small>Note.3</small>	1000ms / 115VAC						
INPUT	VOLTAGE RANGE <small>Note.2</small>	90 ~ 132VAC    127 ~ 186VDC (Please refer to "STATIC CHARACTERISTIC" section)					
	FREQUENCY RANGE	47 ~ 63Hz					
	POWER FACTOR (Typ.)	PF ≥ 0.98/115VAC @full load (Please refer to "POWER FACTOR (PF) CHARACTERISTIC" section)					
	TOTAL HARMONIC DISTORTION	THD < 20%(@load ≥ 50%) (Please refer to "TOTAL HARMONIC DISTORTION(THD)" section)					
	EFFICIENCY (Typ.) <small>Note.4</small>	87.5%					
	AC CURRENT (Typ.)	0.43A/115VAC					
	INRUSH CURRENT (Typ.)	COLD START 15A(twidth=270µs measured at 50% I <sub>peak</sub> ) at 115VAC; Per NEMA 410					
	MAX. No. of PSUs on 16A CIRCUIT BREAKER	22 units (circuit breaker of type B) / 38 units (circuit breaker of type C) at 115VAC					
LEAKAGE CURRENT	<0.5mA / 120VAC						
PROTECTION	SHORT CIRCUIT	Constant current limiting, recovers automatically after fault condition is removed					
	OVER VOLTAGE	110 ~ 130V Shutdown o/p voltage, re-power on to recover					
	OVER TEMPERATURE	Shutdown o/p voltage, re-power on to recover					
FUNCTION	DIMMING	Please refer to "DIMMING OPERATION" section					
	SYNCHRONIZATION	Please refer to "SYNCHRONIZATION OPERATION" section					
	TEMP. COMPENSATION	By external NTC, please refer to "TEMPERATURE COMPENSATION OPERATION" section					
ENVIRONMENT	WORKING TEMP.	T <sub>case</sub> =-30 ~ +90°C (Please refer to "OUTPUT LOAD vs TEMPERATURE" section)					
	MAX. CASE TEMP.	T <sub>case</sub> =+90°C					
	WORKING HUMIDITY	20 ~ 90% RH non-condensing					
	STORAGE TEMP., HUMIDITY	-40 ~ +80°C, 10 ~ 95% RH					
	TEMP. COEFFICIENT	±0.03%/°C (0 ~ 50°C)					
	VIBRATION	10 ~ 500Hz, 2G 10min./1cycle, period for 60min. each along X, Y, Z axes					
SAFETY & EMC	SAFETY STANDARDS	UL8750 approved					
	DALI STANDARDS	Comply with IEC62386-101, 102, 207					
	WITHSTAND VOLTAGE	I/P-O/P:3.75KVAC					
	ISOLATION RESISTANCE	I/P-O/P:>100M Ohms / 500VDC / 25°C / 70% RH					
	EMC EMISSION	Compliance to FCC part 15 Subpart B					
OTHERS	MTBF	193.6K hrs min. MIL-HDBK-217F (25°C)					
	DIMENSION	123.5*81.5*23mm (L*W*H)					
	PACKING	0.28Kg ; 54pcs/16Kg/1.12CUFT					
NOTE	<ol style="list-style-type: none"> <li>All parameters NOT specially mentioned are measured at 115VAC input, rated current and 25°C of ambient temperature.</li> <li>De-rating may be needed under low input voltages. Please refer to "STATIC CHARACTERISTIC" sections for details.</li> <li>Length of set up time is measured at first cold start. Turning ON/OFF the driver may lead to increase of the set up time.</li> <li>Efficiency is measured at 500mA/70V output set by DIP switch.</li> <li>The driver is considered as a component that will be operated in combination with final equipment. Since EMC performance will be affected by the complete installation, the final equipment manufacturers must re-qualify EMC Directive on the complete installation again.</li> <li>It is measured 50%~100% of maximum voltage under rated power delivery.</li> </ol>						

**■ BLOCK DIAGRAM**

PFC fosc : 60KHz  
PWM fosc : 80KHz

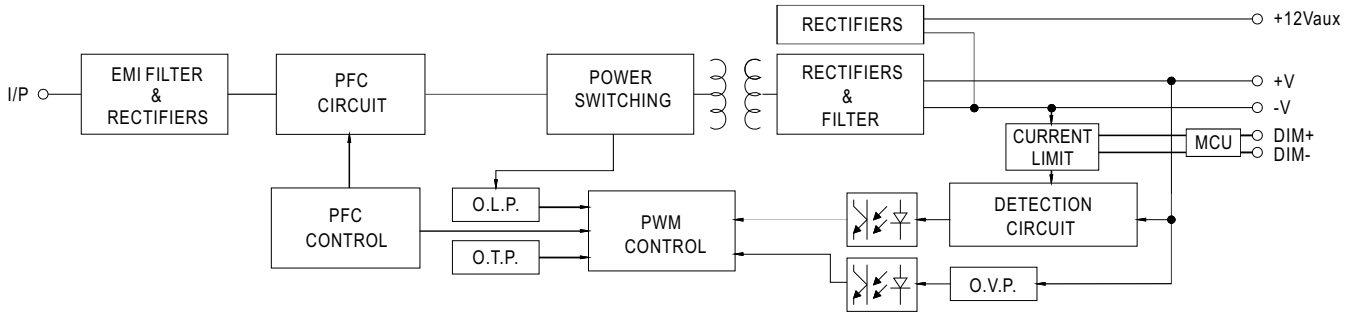

**■ DIP SWITCH TABLE**

LCM-40U is a multiple-stage constant current driver, selection of output current through DIP switch is exhibited below.

Io \ DIP S.W.	1	2	3	4	5	6
350mA	----	----	----	----	----	----
500mA	ON	----	----	----	----	----
600mA	ON	ON	----	----	----	----
700mA(factory default)	ON	ON	ON	----	----	ON
900mA	ON	ON	ON	ON	----	ON
1050mA	ON	ON	ON	ON	ON	ON

**■ DIMMING OPERATION**

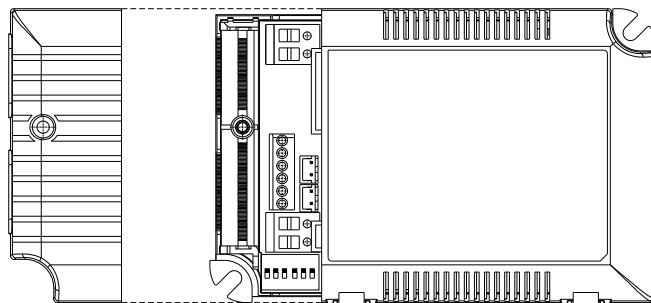

※ **3 in 1 dimming function**

- Output constant current level can be adjusted by applying one of the three methodologies between DIM+ and DIM-: 0 ~ 10VDC, or 10V PWM signal or resistance.
- Direct connecting to LEDs is suggested. It is not suitable to be used with additional drivers.
- Dimming source current from power supply: 100 $\mu$ A (typ.)

◎ Applying additive 0 ~ 10VDC

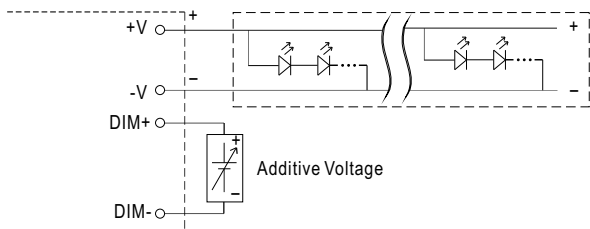

"DO NOT connect "DIM- to -V"

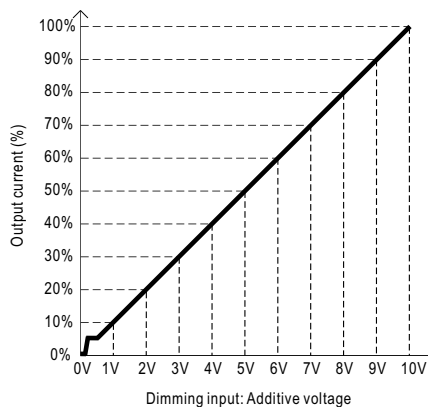

◎ Applying additive 10V PWM signal (frequency range 100Hz ~ 3KHz):

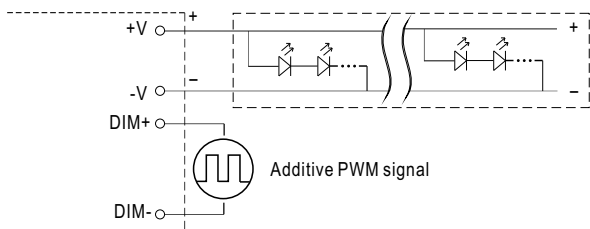

"DO NOT connect "DIM- to -V"

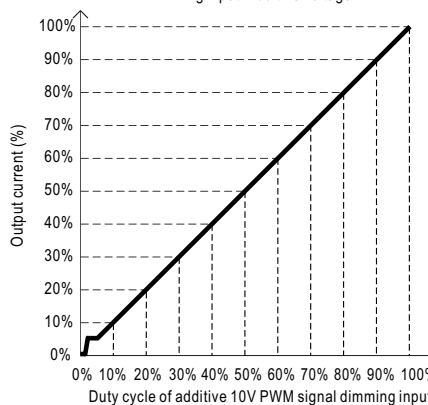

◎ Applying additive resistance:

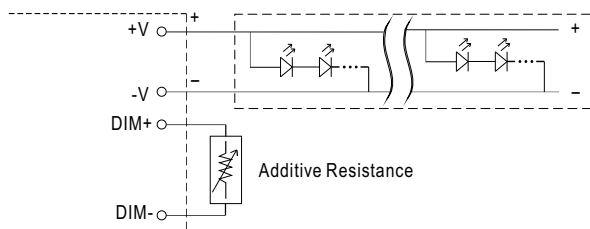

"DO NOT connect "DIM- to -V"

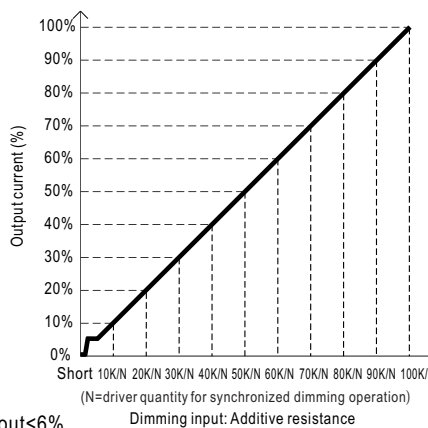

Note : 1. Min. dimming level is about 6% and the output current is not defined when 0% < I<sub>out</sub> < 6%.  
2. The output current could drop down to 0% when dimming input is about 0k $\Omega$  or 0Vdc, or 10V PWM signal with 0% duty cycle.  
3. Please do not activate "temperature compensation" when performing dimming operation.

### ■ SYNCHRONIZATION OPERATION

- Synchronization up to 10 drivers (1 master + 9 slaves)
- Dimming operating range : 10%~100%
- Sync cable length : < 5m
- Sync cable type : Flat cable
- Sync cable cross section area : 22 – 24 AWG (0.2~0.3mm<sup>2</sup>)

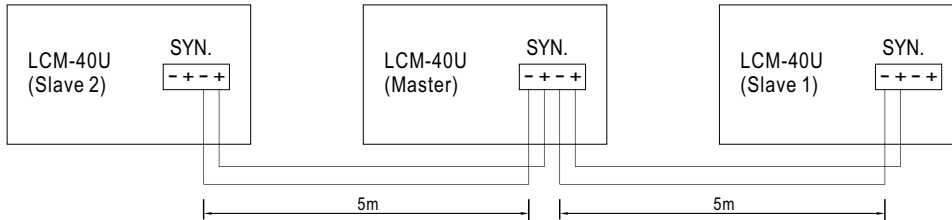

- NOTE: 1. Please make sure all units are set to 100% dimming setting (factory default) before synchronizing.  
2. Min. Dimming operating range depends on dimmer setting.

### ■ TEMPERATURE COMPENSATION OPERATION

LCM-40U have the built-in temperature compensation function ; by connecting a temperature sensor (NTC resistor) between the +NTC / -NTC terminal of LCM-40U and the detecting point on the lighting system or the surrounding environment, output current of LCM-40U could be correspondingly changed, based on the sensed temperature, to ensure the long life of LED.

NTC derating curve

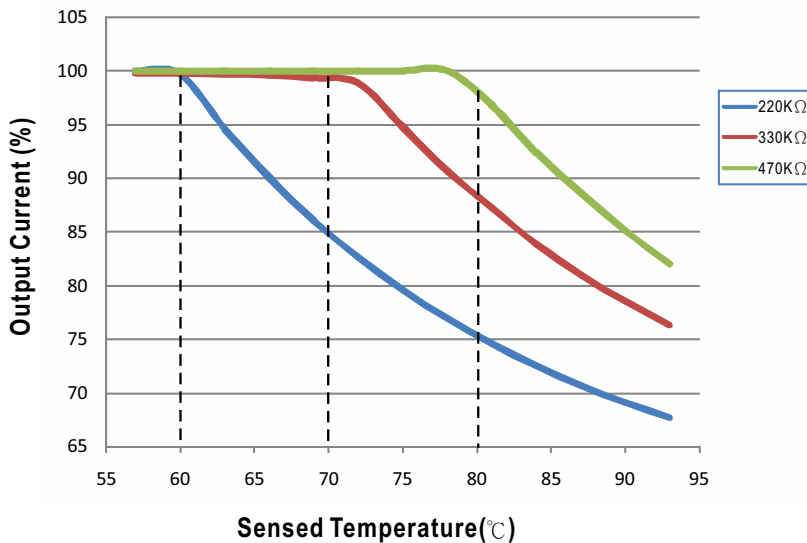

- ⊙ LCM-40U can still be operated normally when the NTC resistor is not connected and the value of output current will be the current level selected through the DIP switch.
- ⊙ NTC reference:

NTC resistance	Output Current
220K	< 60°C, 100% of the rated current (corresponds to the setting current level) > 60°C, output current begins to reduce, please refer to the curve for details.
330K	< 70°C, 100% of the rated current (corresponds to the setting current level) > 70°C, output current begins to reduce, please refer to the curve for details.
470K	< 80°C, 100% of the rated current (corresponds to the setting current level) > 80°C, output current begins to reduce, please refer to the curve for details.

- Notes: 1. MEAN WELL does not offer the NTC resistor and all the data above are measured by using THINKING TTC03 series.  
2. If other brands of NTC resistor is applied, please check the temperature curve first.

- ⊙ Dimming and synchronization function of the driver will be invalid when the "temperature compensation" function is in use.

**OUTPUT LOAD vs TEMPERATURE**

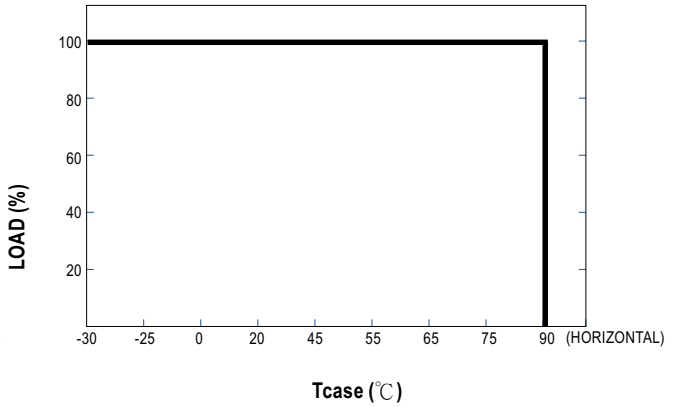
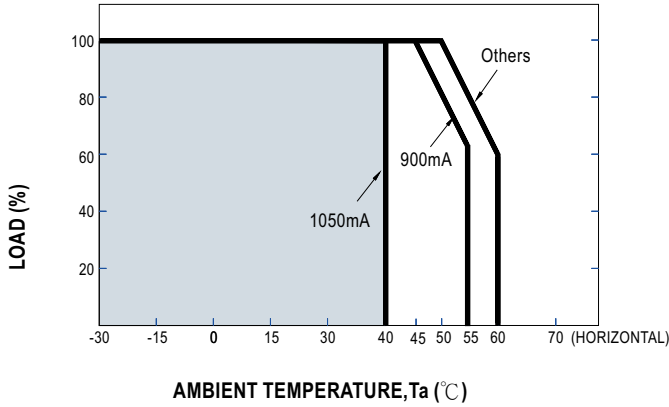

**STATIC CHARACTERISTIC**

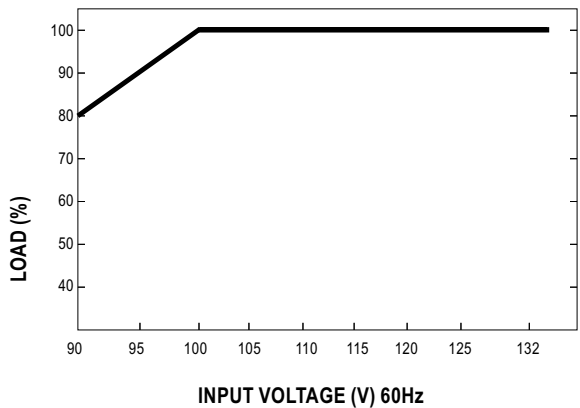

※ De-rating is needed under low input voltage.

**POWER FACTOR (PF) CHARACTERISTIC**

※ Tcase at 80°C

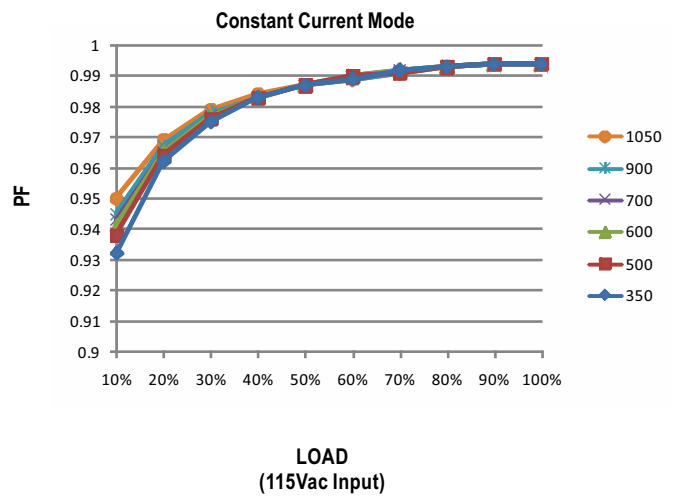

**TOTAL HARMONIC DISTORTION (THD)**

※ Tcase at 80°C

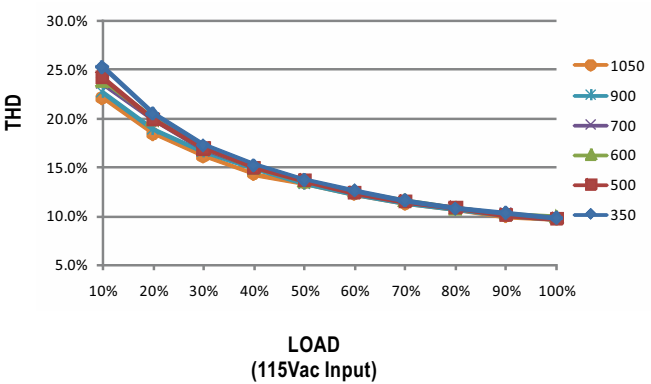

**EFFICIENCY vs LOAD**

LCM-40U series possess superior working efficiency that up to 87.5% can be reached in field applications.

※ Tcase at 80°C

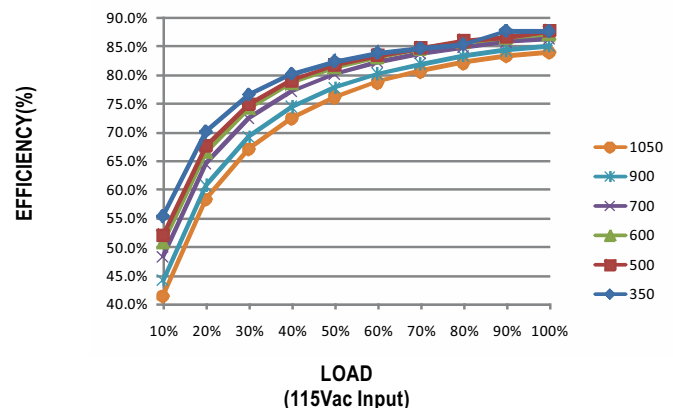

**MECHANICAL SPECIFICATION**

Case No. LCM-60A Unit: mm

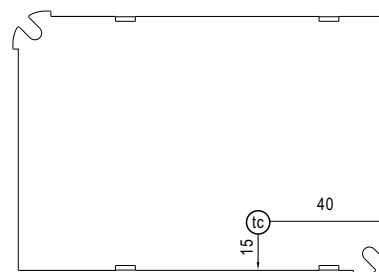
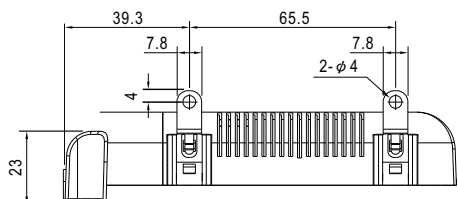
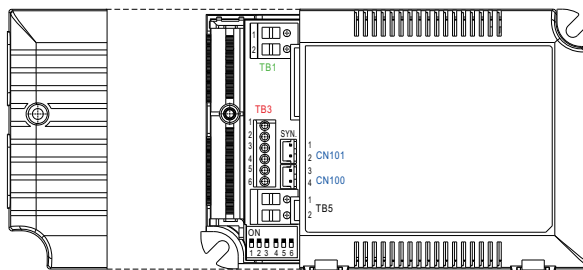
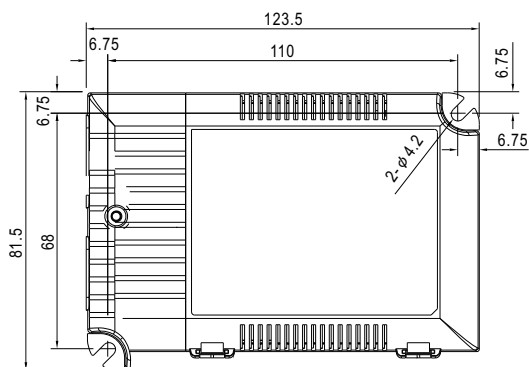

Bottom View

• (tc) : Max. Case Temperature

※ Terminal Pin No. Assignment(TB1)

Pin No.	Assignment
1	AC/L
2	AC/N

※ Terminal Pin No. Assignment(TB3)

Pin No.	Assignment	Pin No.	Assignment	Pin No.	Assignment
1	+FAN	3	+NTC	5	DIM+
2	-FAN	4	-NTC	6	DIM-

◎ Pin1(+FAN) / Pin2(-FAN) is the Auxiliary DC output; it can be used to drive fan.

※ Terminal Pin No. Assignment(TB5)

Pin No.	Assignment
1	+V
2	-V

※ SYN. Connector(CN101/CN100): JST B2B-XH or equivalent

Pin No.	Assignment	Mating Housing	Terminal
1,3	+	JST XHP or equivalent	JST SXH-001T-P0.6 or equivalent
2,4	-		